

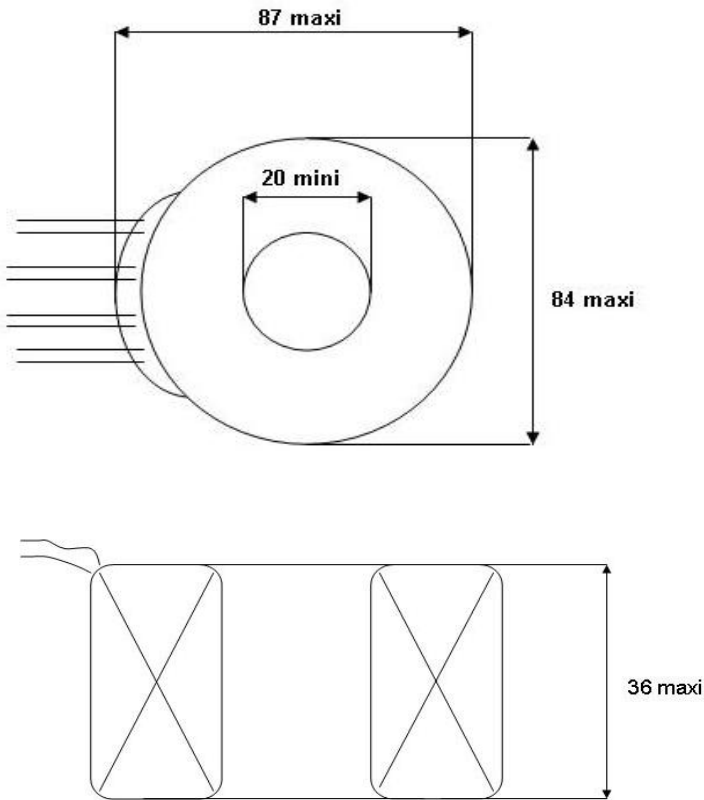

DESCRIPTION : Toroidal Transformer 50 VA

Mechanical schematics



Electrical schematics

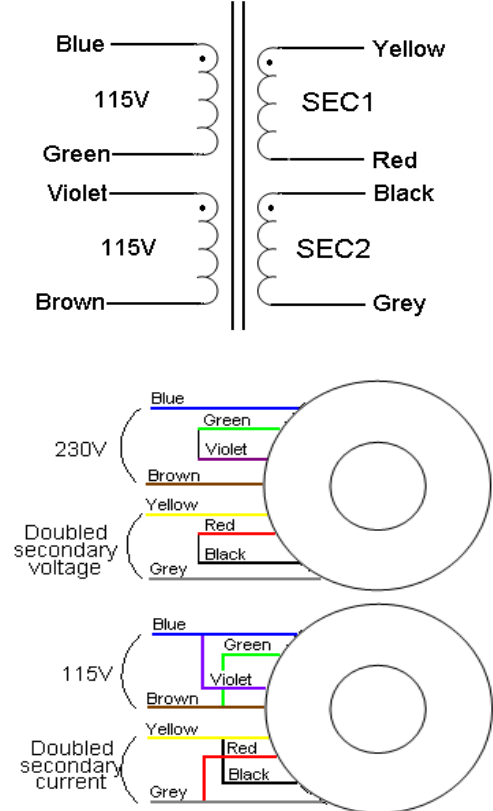

ELECTRICAL DATA

PN	VOLTAGE		NO LOAD VOLTAGE	SECONDARY CURRENT	Ambiant T° T° class	POWER
	PRIMARY	SECONDARY				
S30050D2006	2X115V	2X6V	6,87V	2X4,17A	Ta 50/b	50VA
S30050D2009		2X9V	10,44V	2X2,78A		
S30050D2012		2X12V	13,87V	2X2,08A		
S30050D2015		2X15V	17,16V	2X1,67A		
S30050D2018		2X18V	20,74V	2X1,39A		

GENERAL CHARACTERISTICS	ACCESSORIES	PRINTING
<ul style="list-style-type: none"> - Safety transformers, compliant with NF EN61558 - UL components - Protection rating : IP00 - Approximate weight : 350 g 	<ul style="list-style-type: none"> - 1 Metal washer - Ø int 6 mm - 2 Rubber washer Ø int 6 mm - 1 Screw M6 - 1 Hex nut M6 - 2 Washers Ø 6 mm 	<ul style="list-style-type: none"> - TPE (TECH POWER ELECTRONICS) - PN - DATE CODE - VOLTAGE - POWER - EN 61558