

DATA SHEET

PN : SCF015H040

By Tech Power electronics

**DESCRIPTION : TOROIDAL COMMON MODE CHOKE
2 X 1,5 mH - 4A**

MECHANICAL DIMENSIONS (mm)

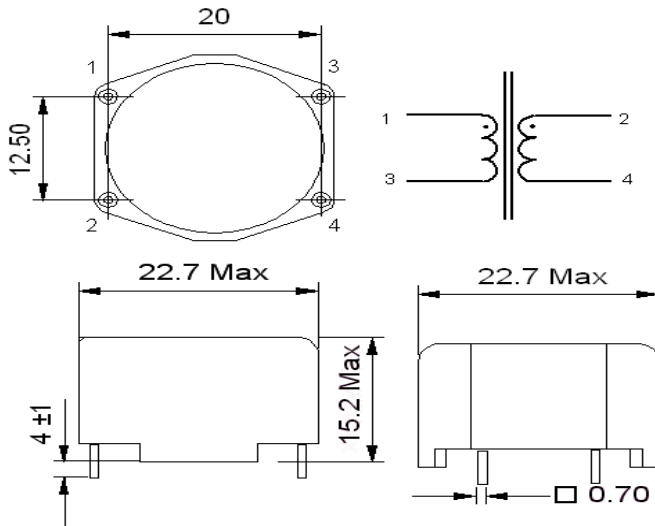

Implantation in holes \varnothing 1,3

ELECTRICAL PROPERTIES

MEASUREMENT CONDITIONS	CHARACTERISTICS	VALUE	UNIT	TOLERANCE
10kHz 10mV	Inductance	1,5	mH	+ 50 % / -30%
25°C	Resistance	35	m Ω	\pm 15%
< 60°C	Nominal Current	4	A	
50Hz	Rated Voltage	250	V	

OTHER PROPERTIES

APPROVALS	TEST CONDITIONS	RoHS COMPLIANT		
UL94 V-0 IEC60938-2 (VDE565-2-1) Climatic Class : 40/125/21 Operating temperature : -40°C to +125°C	Humidity : 33 % Temperature : 25°C Withstanding Voltage : 1500 Vac	Modification	Number	Date
		Creation	1	12/07/11