



TECH POWER
ELECTRONICS GROUP



 **TEAM MAGNETICS**



INDUCTIVE POWER.

AGILE // PRAGMATIC // SINCERE

Driven by innovation, reliable and always focused on solutions – this is how the group-wide expertise within the TECH POWER ELECTRONICS GROUP can be summed up. The six companies SCHWA-MEDICO Transformatoren GmbH, SCHNEEFUSS + ROHDE GmbH, MANFRED SCHMELZER GmbH, MS BALTI Trafo OÜ, MCT Transformatoren GmbH and TECH POWER ELECTRONICS together form a strong alliance capable of shaping the worldwide market with their transformers and industrial products. We are a company with clear values, a commitment to quality, synchronous workflows, lean structures, and a strategy of long-term growth for the entire group.

TRANSFORMER EE20/6.1 0.35 VA

- Frequency / Frequenz 50/60 Hz
- Potted under vacuum / Vakuumvergossen
- Split-bobbin / Zweikammer-Wicklung
- Temperature class / Temperaturklasse ta 70 °C/F
- Short-circuit-proof / Kurzschlussfest
- Weight / Gewicht 0.025 kg
- Other primary and secondary voltages on request / Weitere Primär- und Sekundärspannungen auf Anfrage
- DIN EN 60335-1 glow wire test / Glühdrahtprüfung



Primary (V) Primär (V)	Secondary (V) Sekundär (V)	mA	No-Load Voltage (V) Leerlaufspannung (V)	Schematic-No. Schema-Nr.	Part.-No. Sachnummer	Approvals Approbationen
115	6	58.33		1	01-1014-10	1/2/3/4
115	7.5	46.66		1	01-1015-10	1/2/3/4
115	9	38.88		1	01-1016-10	1/2/3/4
115	12	29.16		1	01-1017-10	1/2/3/4
115	15	23.33		1	01-1018-10	1/2/3/4
115	18	19.44		1	01-1019-10	1/2/3/4
115	21	16.66		1	01-1020-10	1/2/3/4
115	24	14.58		1	01-1021-10	1/2/3/4
115	2 x 6	29.16		2	01-1022-10	1/2/3/4
115	2 x 7.5	23.33		2	01-1023-10	1/2/3/4
115	2 x 9	19.44		2	01-1024-10	1/2/3/4
115	2 x 12	14.58		2	01-1025-10	1/2/3/4
115	2 x 15	11.66		2	01-1026-10	1/2/3/4

Subject to technical changes / Technische Änderungen vorbehalten!

Mechanical dimensions / Mechanische Abmessungen

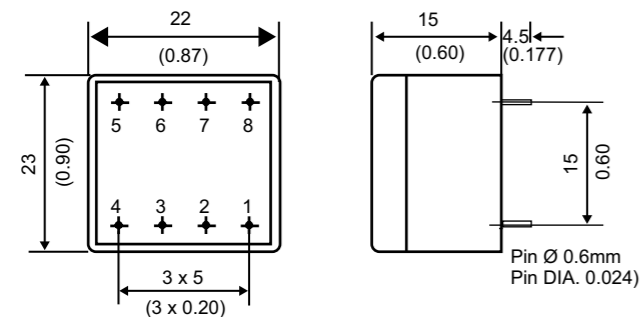

Approvals / Approbationen

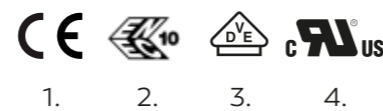

Schematic / Schema

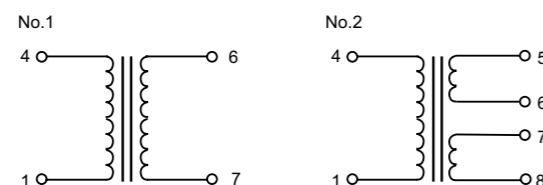

TRANSFORMER EE20/6.1 0.35 VA

- Frequency / Frequenz 50/60 Hz
- Potted under vacuum / Vakuumvergossen
- Split-bobbin / Zweikammer-Wicklung
- Temperature class / Temperaturklasse ta 70 °C/F
- Short-circuit-proof / Kurzschlussfest
- Weight / Gewicht 0.025 kg
- Other primary and secondary voltages on request / Weitere Primär- und Sekundärspannungen auf Anfrage
- DIN EN 60335-1 glow wire test / Glühdrahtprüfung



Primary (V) Primär (V)	Secondary (V) Sekundär (V)	mA	No-Load Voltage (V) Leerlaufspannung (V)	Schematic-No. Schema-Nr.	Part.-No. Sachnummer	Approvals Approbationen
230	6	58.33		1	01-1001-10	1/2/3/4
230	7.5	46.66		1	01-1002-10	1/2/3/4
230	9	38.88		1	01-1003-10	1/2/3/4
230	12	29.16		1	01-1004-10	1/2/3/4
230	15	23.33		1	01-1005-10	1/2/3/4
230	18	19.44		1	01-1006-10	1/2/3/4
230	21	16.66		1	01-1007-10	1/2/3/4
230	24	14.58		1	01-1008-10	1/2/3/4
230	2 x 6	29.16		2	01-1009-10	1/2/3/4
230	2 x 7.5	23.33		2	01-1010-10	1/2/3/4
230	2 x 9	19.44		2	01-1011-10	1/2/3/4
230	2 x 12	14.58		2	01-1012-10	1/2/3/4
230	2 x 15	11.66		2	01-1013-10	1/2/3/4

Subject to technical changes / Technische Änderungen vorbehalten!

Mechanical dimensions / Mechanische Abmessungen

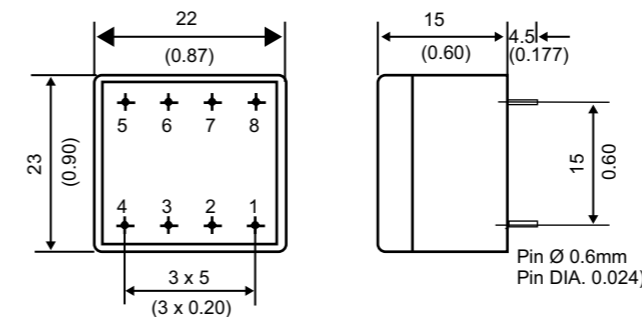

Approvals / Approbationen

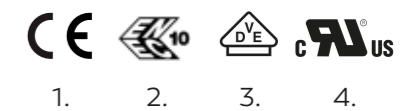

Schematic / Schema

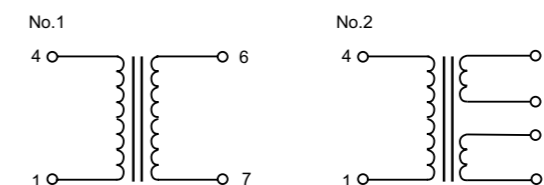

TRANSFORMER EE 20/10 0.50 VA

- Frequency / Frequenz 50/60 Hz
- Potted under vacuum / Vakuumvergossen
- Split-bobbin / Zweikammer-Wicklung
- Temperature class / Temperaturklasse ta 70 °C/F
- Short-circuit-proof / Kurzschlussfest
- Weight / Gewicht 0.036 kg
- Other primary and secondary voltages on request / Weitere Primär- und Sekundärspannungen auf Anfrage
- DIN EN 60335-1 glow wire test / Glühdrahtprüfung



Primary (V) Primär (V)	Secondary (V) Sekundär (V)	mA	No-Load Voltage (V) Leerlaufspannung (V)	Schematic-No. Schema-Nr.	Part.-No. Sachnummer	Approvals Approbationen
115	6	83.33		1	01-2014-10	1/2/3/4
115	7.5	66.66		1	01-2015-10	1/2/3/4
115	9	55.55		1	01-2016-10	1/2/3/4
115	12	41.66		1	01-2017-10	1/2/3/4
115	15	33.33		1	01-2018-10	1/2/3/4
115	18	27.77		1	01-2019-10	1/2/3/4
115	21	23.80		1	01-2020-10	1/2/3/4
115	24	20.83		1	01-2021-10	1/2/3/4
115	2 x 6	41.66		2	01-2022-10	1/2/3/4
115	2 x 7.5	33.33		2	01-2023-10	1/2/3/4
115	2 x 9	27.77		2	01-2024-10	1/2/3/4
115	2 x 12	20.83		2	01-2025-10	1/2/3/4
115	2 x 15	16.66		2	01-2026-10	1/2/3/4

Subject to technical changes / Technische Änderungen vorbehalten!

Mechanical dimensions / Mechanische Abmessungen

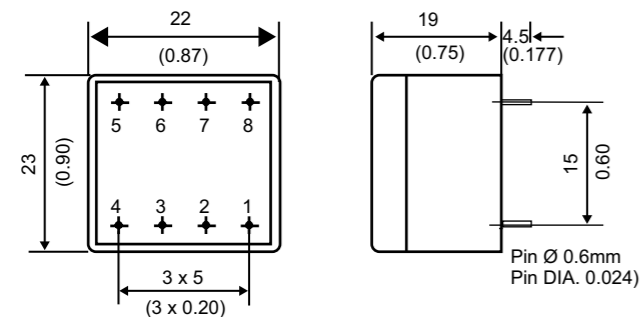

Schematic / Schema

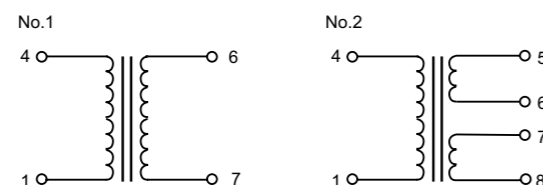

Approvals / Approbationen

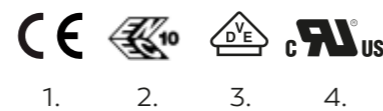

1. 2. 3. 4.

TRANSFORMER EE 20/10 0.50 VA

- Frequency / Frequenz 50/60 Hz
- Potted under vacuum / Vakuumvergossen
- Split-bobbin / Zweikammer-Wicklung
- Temperature class / Temperaturklasse ta 70 °C/F
- Short-circuit-proof / Kurzschlussfest
- Weight / Gewicht 0.036 kg
- Other primary and secondary voltages on request / Weitere Primär- und Sekundärspannungen auf Anfrage
- DIN EN 60335-1 glow wire test / Glühdrahtprüfung



Primary (V) Primär (V)	Secondary (V) Sekundär (V)	mA	No-Load Voltage (V) Leerlaufspannung (V)	Schematic-No. Schema-Nr.	Part.-No. Sachnummer	Approvals Approbationen
230	6	83.33		1	01-2001-10	1/2/3/4
230	7.5	66.66		1	01-2002-10	1/2/3/4
230	9	55.55		1	01-2003-10	1/2/3/4
230	12	41.66		1	01-2004-10	1/2/3/4
230	15	33.33		1	01-2005-10	1/2/3/4
230	18	27.77		1	01-2006-10	1/2/3/4
230	21	23.80		1	01-2007-10	1/2/3/4
230	24	20.83		1	01-2008-10	1/2/3/4
230	2 x 6	41.66		2	01-2009-10	1/2/3/4
230	2 x 7.5	33.33		2	01-2010-10	1/2/3/4
230	2 x 9	27.77		2	01-2011-10	1/2/3/4
230	2 x 12	20.83		2	01-2012-10	1/2/3/4
230	2 x 15	16.66		2	01-2013-10	1/2/3/4

Subject to technical changes / Technische Änderungen vorbehalten!

Mechanical dimensions / Mechanische Abmessungen

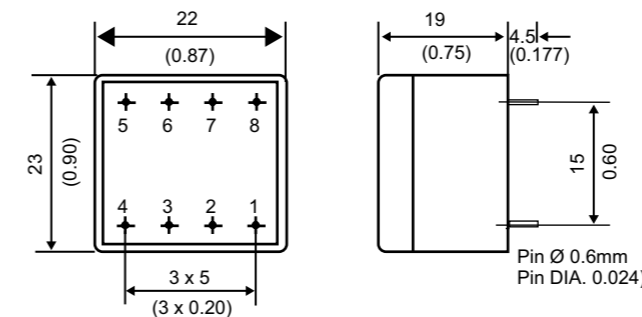

Schematic / Schema

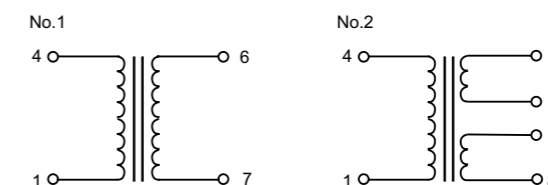

Approvals / Approbationen

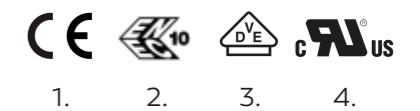

1. 2. 3. 4.

TRANSFORMER EI 30/5 0.50 VA

- Frequency / Frequenz 50/60 Hz
- Potted under vacuum / Vakuumvergossen
- Split-bobbin / Zweikammer-Wicklung
- Temperature class / Temperaturklasse ta 70 °C/F
- Short-circuit-proof / Kurzschlussfest
- Weight / Gewicht 0.043 kg
- Other primary and secondary voltages on request / Weitere Primär- und Sekundärspannungen auf Anfrage
- DIN EN 60335-1 glow wire test / Glühdrahtprüfung



Primary (V) Primär (V)	Secondary (V) Sekundär (V)	mA	No-Load Voltage (V) Leerlaufspannung (V)	Schematic-No. Schema-Nr.	Part.-No. Sachnummer	Approvals Approbationen
115	6	83.33	10.40	1	03-0014-10	1/2/3/4
115	7.5	66.67	13.35	1	03-0015-10	1/2/3/4
115	9	55.56	16.00	1	03-0016-10	1/2/3/4
115	12	41.67	21.34	1	03-0017-10	1/2/3/4
115	15	33.33	26.20	1	03-0018-10	1/2/3/4
115	18	27.78	30.28	1	03-0019-10	1/2/3/4
115	21	23.81	34.70	1	03-0020-10	1/2/3/4
115	24	20.83	39.00	1	03-0021-10	1/2/3/4
115	2 x 6	41.67	2 x 11.24	2	03-0022-10	1/2/3/4
115	2 x 7.5	33.33	2 x 13.74	2	03-0023-10	1/2/3/4
115	2 x 9	27.78	2 x 16.00	2	03-0024-10	1/2/3/4
115	2 x 12	20.83	2 x 20.40	2	03-0025-10	1/2/3/4
115	2 x 15	16.66	2 x 24.92	2	03-0026-10	1/2/3/4

Subject to technical changes / Technische Änderungen vorbehalten!

Mechanical dimensions / Mechanische Abmessungen

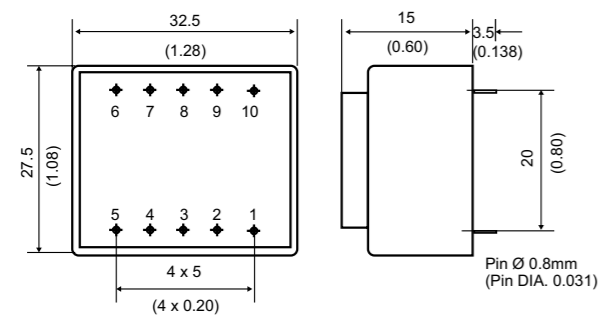

Approvals / Approbationen

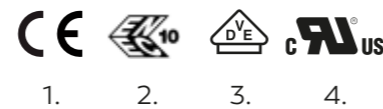

Schematic / Schema

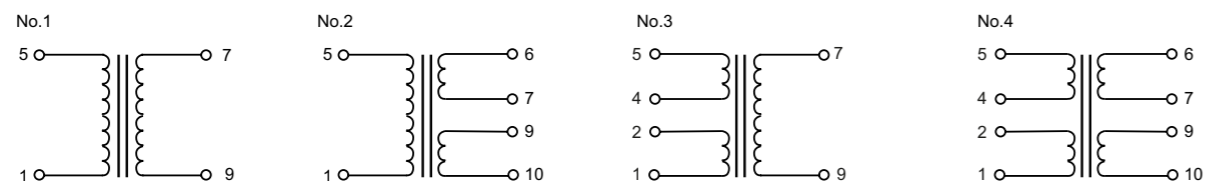

TRANSFORMER EI 30/5 0.50 VA

- Frequency / Frequenz 50/60 Hz
- Potted under vacuum / Vakuumvergossen
- Split-bobbin / Zweikammer-Wicklung
- Temperature class / Temperaturklasse ta 70 °C/F
- Short-circuit-proof / Kurzschlussfest
- Weight / Gewicht 0.043 kg
- Other primary and secondary voltages on request / Weitere Primär- und Sekundärspannungen auf Anfrage
- DIN EN 60335-1 glow wire test / Glühdrahtprüfung



Primary (V) Primär (V)	Secondary (V) Sekundär (V)	mA	No-Load Voltage (V) Leerlaufspannung (V)	Schematic-No. Schema-Nr.	Part.-No. Sachnummer	Approvals Approbationen
230	6	83.33	10.40	1	03-0001-10	1/2/3/4
230	7.5	66.67	13.35	1	03-0002-10	1/2/3/4
230	9	55.56	16.00	1	03-0003-10	1/2/3/4
230	12	41.67	21.34	1	03-0004-10	1/2/3/4
230	15	33.33	26.20	1	03-0005-10	1/2/3/4
230	18	27.78	30.28	1	03-0006-10	1/2/3/4
230	21	23.81	34.70	1	03-0007-10	1/2/3/4
230	24	20.83	39.00	1	03-0008-10	1/2/3/4
230	2 x 6	41.67	2 x 11.24	2	03-0009-10	1/2/3/4
230	2 x 7.5	33.33	2 x 13.74	2	03-0010-10	1/2/3/4
230	2 x 9	27.78	2 x 16.00	2	03-0011-10	1/2/3/4
230	2 x 12	20.83	2 x 20.40	2	03-0012-10	1/2/3/4
230	2 x 15	16.66	2 x 24.92	2	03-0013-10	1/2/3/4

Subject to technical changes / Technische Änderungen vorbehalten!

Mechanical dimensions / Mechanische Abmessungen

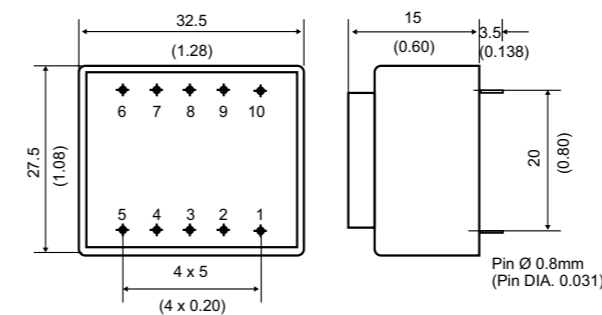

Approvals / Approbationen

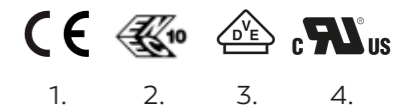

Schematic / Schema



TRANSFORMER EI 30/5 0.50 VA

- Frequency / Frequenz 50/60 Hz
- Potted under vacuum / Vakuumvergossen
- Split-bobbin / Zweikammer-Wicklung
- Temperature class / Temperaturklasse ta 70 °C/F
- Short-circuit-proof / Kurzschlussfest
- Weight / Gewicht 0.043 kg
- Other primary and secondary voltages on request / Weitere Primär- und Sekundärspannungen auf Anfrage
- DIN EN 60335-1 glow wire test / Glühdrahtprüfung



Primary (V) Primär (V)	Secondary (V) Sekundär (V)	mA	No-Load Voltage (V) Leerlaufspannung (V)	Schematic-No. Schema-Nr.	Part.-No. Sachnummer	Approvals Approbationen
2 x 115	6	83.33	10.40	3	03-0027-10	1/2/3/4
2 x 115	7.5	66.67	13.35	3	03-0028-10	1/2/3/4
2 x 115	9	55.56	16.00	3	03-0029-10	1/2/3/4
2 x 115	12	41.67	21.34	3	03-0030-10	1/2/3/4
2 x 115	15	33.33	26.20	3	03-0031-10	1/2/3/4
2 x 115	18	27.78	30.28	3	03-0032-10	1/2/3/4
2 x 115	21	23.81	34.70	3	03-0033-10	1/2/3/4
2 x 115	24	20.83	39.00	3	03-0034-10	1/2/3/4
2 x 115	2 x 6	41.67	2 x 11.24	4	03-0035-10	1/2/3/4
2 x 115	2 x 7.5	33.33	2 x 13.74	4	03-0036-10	1/2/3/4
2 x 115	2 x 9	27.78	2 x 16.00	4	03-0037-10	1/2/3/4
2 x 115	2 x 12	20.83	2 x 20.40	4	03-0038-10	1/2/3/4
2 x 115	2 x 15	16.66	2 x 24.92	4	03-0039-10	1/2/3/4

Subject to technical changes / Technische Änderungen vorbehalten!

Mechanical dimensions / Mechanische Abmessungen

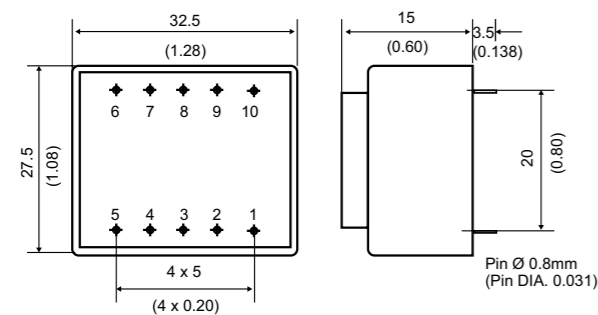

Approvals / Approbationen

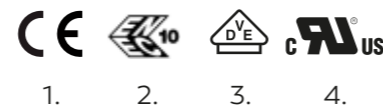

Schematic / Schema

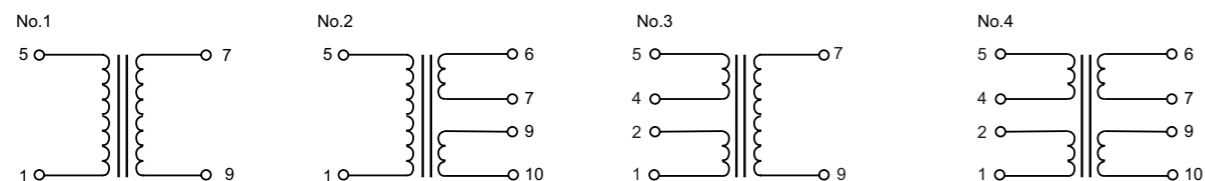

TRANSFORMER EI 30/10.5 1.50 VA

- Frequency / Frequenz 50/60 Hz
- Potted under vacuum / Vakuumvergossen
- Split-bobbin / Zweikammer-Wicklung
- Temperature class / Temperaturklasse ta 70 °C/F
- Short-circuit-proof / Kurzschlussfest
- Weight / Gewicht 0.073 kg
- Other primary and secondary voltages on request / Weitere Primär- und Sekundärspannungen auf Anfrage
- DIN EN 60335-1 glow wire test / Glühdrahtprüfung



Primary (V) Primär (V)	Secondary (V) Sekundär (V)	mA	No-Load Voltage (V) Leerlaufspannung (V)	Schematic-No. Schema-Nr.	Part.-No. Sachnummer	Approvals Approbationen
115	6	250.00	9.69	1	03-1014-10	1/2/3/4
115	7.5	200.00	11.80	1	03-1015-10	1/2/3/4
115	9	166.67	13.90	1	03-1016-10	1/2/3/4
115	12	125.00	19.00	1	03-1017-10	1/2/3/4
115	15	100.00	22.50	1	03-1018-10	1/2/3/4
115	18	83.33	27.45	1	03-1019-10	1/2/3/4
115	21	71.43	32.80	1	03-1020-10	1/2/3/4
115	24	62.50	38.50	1	03-1021-10	1/2/3/4
115	2 x 6	125.00	2 x 10.40	2	03-1022-10	1/2/3/4
115	2 x 7.5	100.00	2 x 13.00	2	03-1023-10	1/2/3/4
115	2 x 9	83.33	2 x 14.40	2	03-1024-10	1/2/3/4
115	2 x 12	62.50	2 x 18.95	2	03-1025-10	1/2/3/4
115	2 x 15	50.00	2 x 23.50	2	03-1026-10	1/2/3/4

Subject to technical changes / Technische Änderungen vorbehalten!

Mechanical dimensions / Mechanische Abmessungen

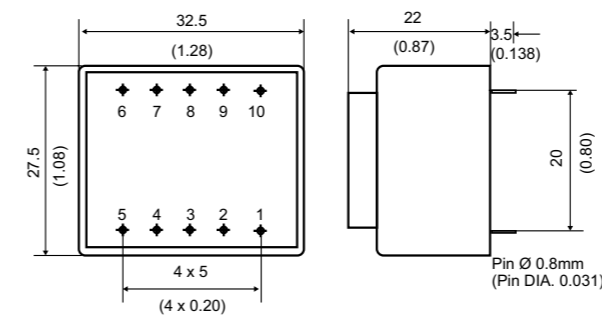

Approvals / Approbationen

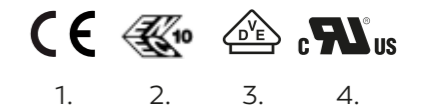

Schematic / Schema



TRANSFORMER EI 30/10.5 1.50 VA

- Frequency / Frequenz 50/60 Hz
- Potted under vacuum / Vakuumvergossen
- Split-bobbin / Zweikammer-Wicklung
- Temperature class / Temperaturklasse ta 70 °C/F
- Short-circuit-proof / Kurzschlussfest
- Weight / Gewicht 0.073 kg
- Other primary and secondary voltages on request / Weitere Primär- und Sekundärspannungen auf Anfrage
- DIN EN 60335-1 glow wire test / Glühdrahtprüfung



Primary (V) Primär (V)	Secondary (V) Sekundär (V)	mA	No-Load Voltage (V) Leerlaufspannung (V)	Schematic-No. Schema-Nr.	Part.-No. Sachnummer	Approvals Approbationen
230	6	250.00	9.69	1	03-1001-10	1/2/3/4
230	7.5	200.00	11.80	1	03-1002-10	1/2/3/4
230	9	166.67	13.90	1	03-1003-10	1/2/3/4
230	12	125.00	19.00	1	03-1004-10	1/2/3/4
230	15	100.00	22.50	1	03-1005-10	1/2/3/4
230	18	83.33	27.45	1	03-1006-10	1/2/3/4
230	21	71.43	32.80	1	03-1007-10	1/2/3/4
230	24	62.50	38.50	1	03-1008-10	1/2/3/4
230	2 x 6	125.00	2 x 10.40	2	03-1009-10	1/2/3/4
230	2 x 7.5	100.00	2 x 13.00	2	03-1010-10	1/2/3/4
230	2 x 9	83.33	2 x 14.40	2	03-1011-10	1/2/3/4
230	2 x 12	62.50	2 x 18.95	2	03-1012-10	1/2/3/4
230	2 x 15	50.00	2 x 23.50	2	03-1013-10	1/2/3/4

Subject to technical changes / Technische Änderungen vorbehalten!

Mechanical dimensions / Mechanische Abmessungen

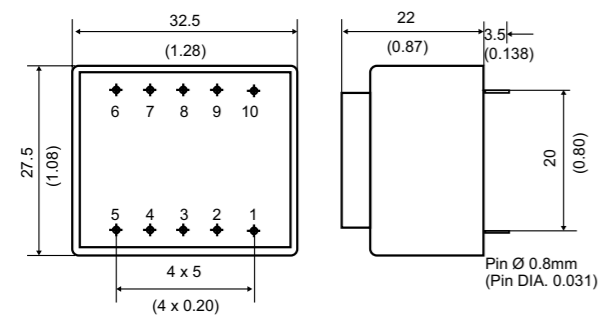

Approvals / Approbationen

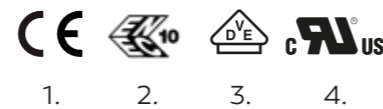

Schematic / Schema

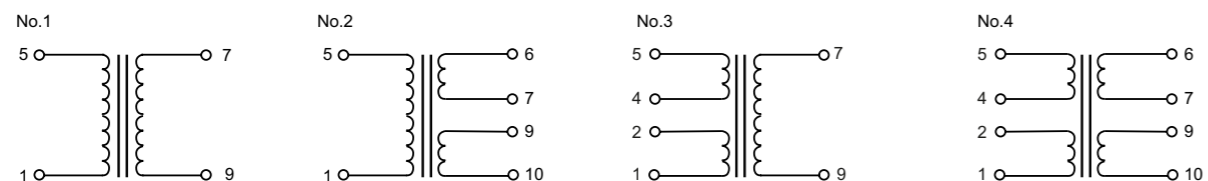

TRANSFORMER EI 30/10.5 1.50 VA

- Frequency / Frequenz 50/60 Hz
- Potted under vacuum / Vakuumvergossen
- Split-bobbin / Zweikammer-Wicklung
- Temperature class / Temperaturklasse ta 70 °C/F
- Short-circuit-proof / Kurzschlussfest
- Weight / Gewicht 0.073 kg
- Other primary and secondary voltages on request / Weitere Primär- und Sekundärspannungen auf Anfrage
- DIN EN 60335-1 glow wire test / Glühdrahtprüfung



Primary (V) Primär (V)	Secondary (V) Sekundär (V)	mA	No-Load Voltage (V) Leerlaufspannung (V)	Schematic-No. Schema-Nr.	Part.-No. Sachnummer	Approvals Approbationen
2 x 115	6	250.00	9.69	3	03-1027-10	1/2/3/4
2 x 115	7.5	200.00	11.80	3	03-1028-10	1/2/3/4
2 x 115	9	166.67	13.90	3	03-1029-10	1/2/3/4
2 x 115	12	125.00	19.00	3	03-1030-10	1/2/3/4
2 x 115	15	100.00	22.50	3	03-1031-10	1/2/3/4
2 x 115	18	83.33	27.45	3	03-1032-10	1/2/3/4
2 x 115	21	71.43	32.80	3	03-1033-10	1/2/3/4
2 x 115	24	62.50	38.50	3	03-1034-10	1/2/3/4
2 x 115	2 x 6	125.00	2 x 10.40	4	03-1035-10	1/2/3/4
2 x 115	2 x 7.5	100.00	2 x 13.00	4	03-1036-10	1/2/3/4
2 x 115	2 x 9	83.33	2 x 14.40	4	03-1037-10	1/2/3/4
2 x 115	2 x 12	62.50	2 x 18.95	4	03-1038-10	1/2/3/4
2 x 115	2 x 15	50.00	2 x 23.50	4	03-1039-10	1/2/3/4

Subject to technical changes / Technische Änderungen vorbehalten!

Mechanical dimensions / Mechanische Abmessungen

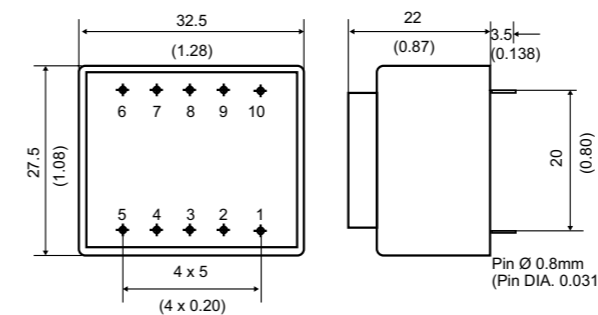

Approvals / Approbationen

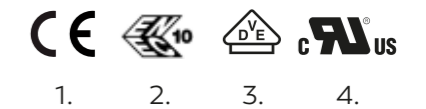

Schematic / Schema



TRANSFORMER EI 30/12.5 1.90 VA

- Frequency / Frequenz 50/60 Hz
- Potted under vacuum / Vakuumvergossen
- Split-bobbin / Zweikammer-Wicklung
- Temperature class / Temperaturklasse ta 70 °C/F
- Short-circuit-proof / Kurzschlussfest
- Weight / Gewicht 0.084 kg
- Other primary and secondary voltages on request / Weitere Primär- und Sekundärspannungen auf Anfrage
- DIN EN 60335-1 glow wire test / Glühdrahtprüfung



Primary (V) Primär (V)	Secondary (V) Sekundär (V)	mA	No-Load Voltage (V) Leerlaufspannung (V)	Schematic-No. Schema-Nr.	Part.-No. Sachnummer	Approvals Approbationen
115	6	316.67	10.00	1	03-2014-10	1/2/3/4
115	7.5	253.33	12.55	1	03-2015-10	1/2/3/4
115	9	211.11	15.20	1	03-2016-10	1/2/3/4
115	12	158.33	19.85	1	03-2017-10	1/2/3/4
115	15	126.67	24.10	1	03-2018-10	1/2/3/4
115	18	105.56	29.75	1	03-2019-10	1/2/3/4
115	21	90.48	34.75	1	03-2020-10	1/2/3/4
115	24	79.17	39.50	1	03-2021-10	1/2/3/4
115	2 x 6	158.33	2 x 10.36	2	03-2022-10	1/2/3/4
115	2 x 7.5	126.67	2 x 12.78	2	03-2023-10	1/2/3/4
115	2 x 9	105.56	2 x 15.10	2	03-2024-10	1/2/3/4
115	2 x 12	79.17	2 x 20.28	2	03-2025-10	1/2/3/4
115	2 x 15	63.33	2 x 25.00	2	03-2026-10	1/2/3/4

Subject to technical changes / Technische Änderungen vorbehalten!

Mechanical dimensions / Mechanische Abmessungen

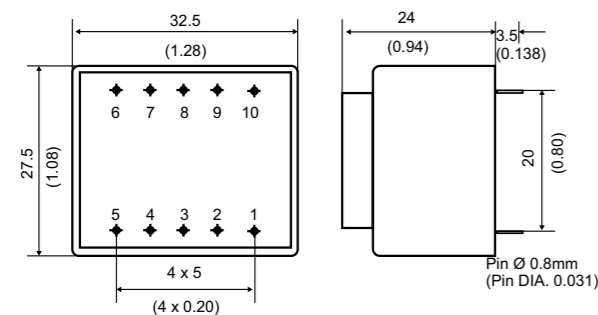

Approvals / Approbationen

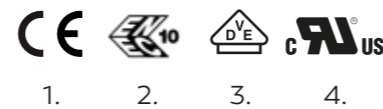

Schematic / Schema

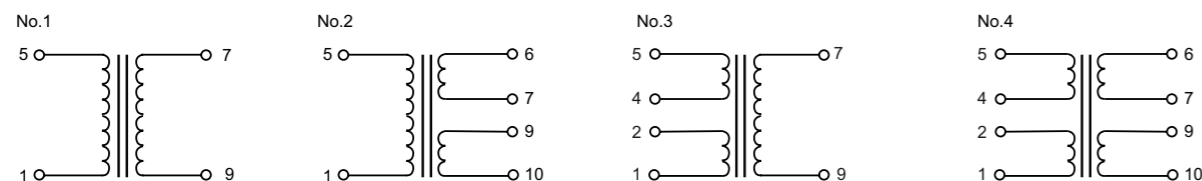

TRANSFORMER EI 30/12.5 1.90 VA

- Frequency / Frequenz 50/60 Hz
- Potted under vacuum / Vakuumvergossen
- Split-bobbin / Zweikammer-Wicklung
- Temperature class / Temperaturklasse ta 70 °C/F
- Short-circuit-proof / Kurzschlussfest
- Weight / Gewicht 0.084 kg
- Other primary and secondary voltages on request / Weitere Primär- und Sekundärspannungen auf Anfrage
- DIN EN 60335-1 glow wire test / Glühdrahtprüfung



Primary (V) Primär (V)	Secondary (V) Sekundär (V)	mA	No-Load Voltage (V) Leerlaufspannung (V)	Schematic-No. Schema-Nr.	Part.-No. Sachnummer	Approvals Approbationen
230	6	316.67	10.00	1	03-2001-10	1/2/3/4
230	7.5	253.33	12.55	1	03-2002-10	1/2/3/4
230	9	211.11	15.20	1	03-2003-10	1/2/3/4
230	12	158.33	19.85	1	03-2004-10	1/2/3/4
230	15	126.67	24.10	1	03-2005-10	1/2/3/4
230	18	105.56	29.75	1	03-2006-10	1/2/3/4
230	21	90.48	34.75	1	03-2007-10	1/2/3/4
230	24	79.17	39.50	1	03-2008-10	1/2/3/4
230	2 x 6	158.33	2 x 10.36	2	03-2009-10	1/2/3/4
230	2 x 7.5	126.67	2 x 12.78	2	03-2010-10	1/2/3/4
230	2 x 9	105.56	2 x 15.10	2	03-2011-10	1/2/3/4
230	2 x 12	79.17	2 x 20.28	2	03-2012-10	1/2/3/4
230	2 x 15	63.33	2 x 25.00	2	03-2013-10	1/2/3/4

Subject to technical changes / Technische Änderungen vorbehalten!

Mechanical dimensions / Mechanische Abmessungen

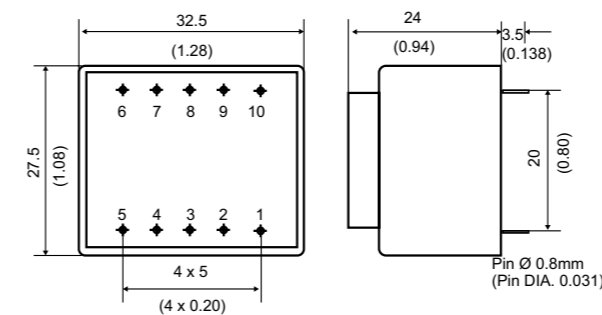

Approvals / Approbationen

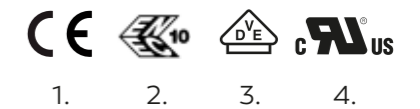

Schematic / Schema



TRANSFORMER EI 30/12.5 1.90 VA

- Frequency / Frequenz 50/60 Hz
- Potted under vacuum / Vakuumvergossen
- Split-bobbin / Zweikammer-Wicklung
- Temperature class / Temperaturklasse ta 70 °C/F
- Short-circuit-proof / Kurzschlussfest
- Weight / Gewicht 0.084 kg
- Other primary and secondary voltages on request / Weitere Primär- und Sekundärspannungen auf Anfrage
- DIN EN 60335-1 glow wire test / Glühdrahtprüfung



Primary (V) Primär (V)	Secondary (V) Sekundär (V)	mA	No-Load Voltage (V) Leerlaufspannung (V)	Schematic-No. Schema-Nr.	Part.-No. Sachnummer	Approvals Approbationen
2 x 115	6	316.67	10.00	3	03-2027-10	1/2/3/4
2 x 115	7.5	253.33	12.55	3	03-2028-10	1/2/3/4
2 x 115	9	211.11	15.20	3	03-2029-10	1/2/3/4
2 x 115	12	158.33	19.85	3	03-2030-10	1/2/3/4
2 x 115	15	126.67	24.10	3	03-2031-10	1/2/3/4
2 x 115	18	105.56	29.75	3	03-2032-10	1/2/3/4
2 x 115	21	90.48	34.75	3	03-2033-10	1/2/3/4
2 x 115	24	79.17	39.50	3	03-2034-10	1/2/3/4
2 x 115	2 x 6	158.33	2 x 10.36	4	03-2035-10	1/2/3/4
2 x 115	2 x 7.5	126.67	2 x 12.78	4	03-2036-10	1/2/3/4
2 x 115	2 x 9	105.56	2 x 15.10	4	03-2037-10	1/2/3/4
2 x 115	2 x 12	79.17	2 x 20.28	4	03-2038-10	1/2/3/4
2 x 115	2 x 15	63.33	2 x 25.00	4	03-2039-10	1/2/3/4

Subject to technical changes / Technische Änderungen vorbehalten!

Mechanical dimensions / Mechanische Abmessungen

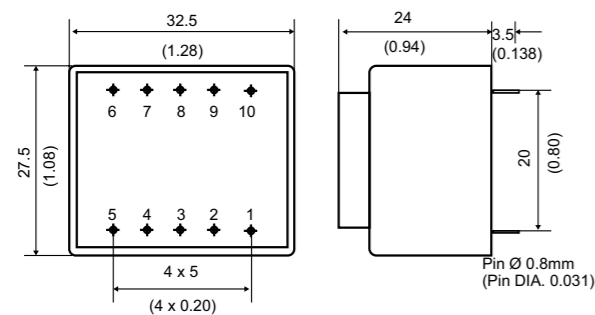

Approvals / Approbationen

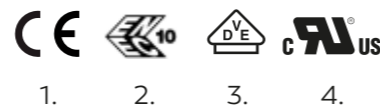

Schematic / Schema

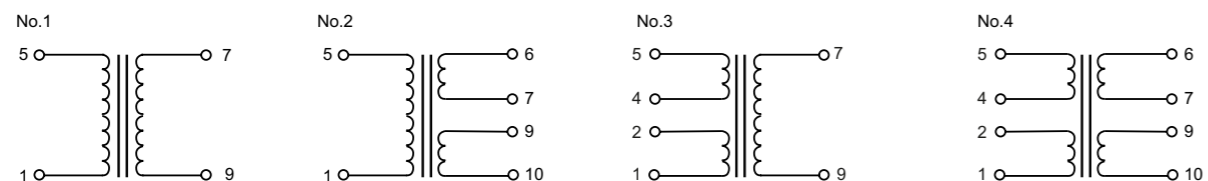

TRANSFORMER EI 30/15.5 2.10 VA

- Frequency / Frequenz 50/60 Hz
- Potted under vacuum / Vakuumvergossen
- Split-bobbin / Zweikammer-Wicklung
- Temperature class / Temperaturklasse ta 70 °C/F
- Short-circuit-proof / Kurzschlussfest
- Weight / Gewicht 0.10 kg
- Other primary and secondary voltages on request / Weitere Primär- und Sekundärspannungen auf Anfrage
- DIN EN 60335-1 glow wire test / Glühdrahtprüfung



Primary (V) Primär (V)	Secondary (V) Sekundär (V)	mA	No-Load Voltage (V) Leerlaufspannung (V)	Schematic-No. Schema-Nr.	Part.-No. Sachnummer	Approvals Approbationen
115	6	350.00	9.34	1	03-3014-10	1/2/3/4
115	7.5	280.00	11.45	1	03-3015-10	1/2/3/4
115	9	233.33	14.18	1	03-3016-10	1/2/3/4
115	12	175.00	18.34	1	03-3017-10	1/2/3/4
115	15	140.00	22.92	1	03-3018-10	1/2/3/4
115	18	116.67	26.25	1	03-3019-10	1/2/3/4
115	21	100.00	29.56	1	03-3020-10	1/2/3/4
115	24	87.50	34.55	1	03-3021-10	1/2/3/4
115	2 x 6	175.00	2 x 10.26	2	03-3022-10	1/2/3/4
115	2 x 7.5	140.00	2 x 12.03	2	03-3023-10	1/2/3/4
115	2 x 9	116.67	2 x 14.10	2	03-3024-10	1/2/3/4
115	2 x 12	87.50	2 x 18.85	2	03-3025-10	1/2/3/4
115	2 x 15	70.00	2 x 22.92	2	03-3026-10	1/2/3/4

Subject to technical changes / Technische Änderungen vorbehalten!

Mechanical dimensions / Mechanische Abmessungen

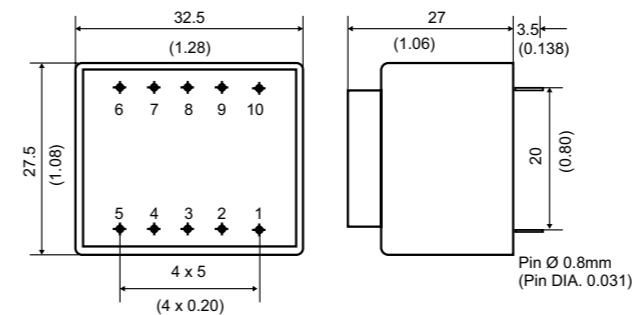

Approvals / Approbationen

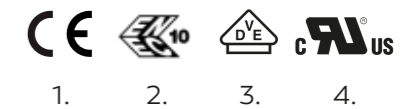

Schematic / Schema



TRANSFORMER EI 30/15.5 2.10 VA

- Frequency / Frequenz 50/60 Hz
- Potted under vacuum / Vakuumvergossen
- Split-bobbin / Zweikammer-Wicklung
- Temperature class / Temperaturklasse ta 70 °C/F
- Short-circuit-proof / Kurzschlussfest
- Weight / Gewicht 0.10 kg
- Other primary and secondary voltages on request / Weitere Primär- und Sekundärspannungen auf Anfrage
- DIN EN 60335-1 glow wire test / Glühdrahtprüfung



Primary (V) Primär (V)	Secondary (V) Sekundär (V)	mA	No-Load Voltage (V) Leerlaufspannung (V)	Schematic-No. Schema-Nr.	Part.-No. Sachnummer	Approvals Approbationen
230	6	350.00	9.34	1	03-3001-10	1/2/3/4
230	7.5	280.00	11.45	1	03-3002-10	1/2/3/4
230	9	233.33	14.18	1	03-3003-10	1/2/3/4
230	12	175.00	18.34	1	03-3004-10	1/2/3/4
230	15	140.00	22.92	1	03-3005-10	1/2/3/4
230	18	116.67	26.25	1	03-3006-10	1/2/3/4
230	21	100.00	29.56	1	03-3007-10	1/2/3/4
230	24	87.50	34.55	1	03-3008-10	1/2/3/4
230	2 x 6	175.00	2 x 10.26	2	03-3009-10	1/2/3/4
230	2 x 7.5	140.00	2 x 12.03	2	03-3010-10	1/2/3/4
230	2 x 9	116.67	2 x 14.10	2	03-3011-10	1/2/3/4
230	2 x 12	87.50	2 x 18.85	2	03-3012-10	1/2/3/4
230	2 x 15	70.00	2 x 22.92	2	03-3013-10	1/2/3/4

Subject to technical changes / Technische Änderungen vorbehalten!

Mechanical dimensions / Mechanische Abmessungen

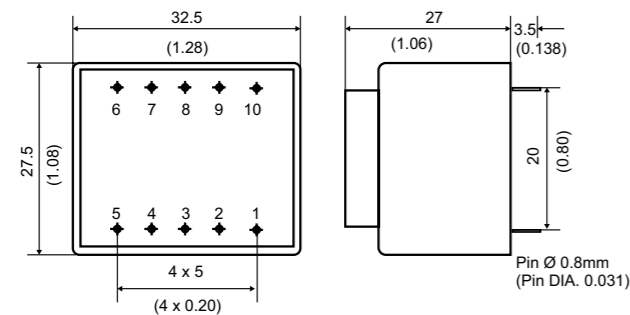

Approvals / Approbationen

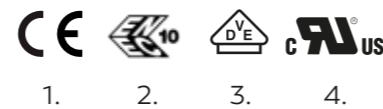

Schematic / Schema

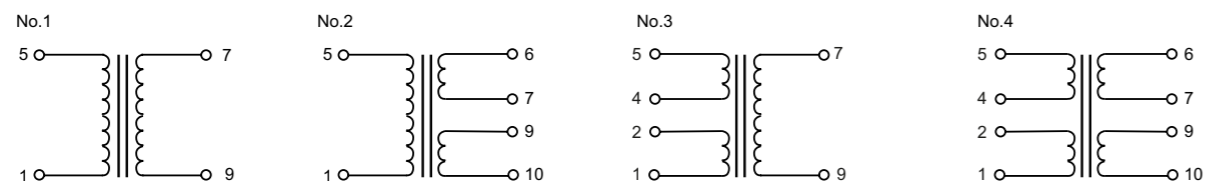

TRANSFORMER EI 30/15.5 2.10 VA

- Frequency / Frequenz 50/60 Hz
- Potted under vacuum / Vakuumvergossen
- Split-bobbin / Zweikammer-Wicklung
- Temperature class / Temperaturklasse ta 70 °C/F
- Short-circuit-proof / Kurzschlussfest
- Weight / Gewicht 0.10 kg
- Other primary and secondary voltages on request / Weitere Primär- und Sekundärspannungen auf Anfrage
- DIN EN 60335-1 glow wire test / Glühdrahtprüfung



Primary (V) Primär (V)	Secondary (V) Sekundär (V)	mA	No-Load Voltage (V) Leerlaufspannung (V)	Schematic-No. Schema-Nr.	Part.-No. Sachnummer	Approvals Approbationen
2 x 115	6	350.00	9.34	3	03-3027-10	1/2/3/4
2 x 115	7.5	280.00	11.45	3	03-3028-10	1/2/3/4
2 x 115	9	233.33	14.18	3	03-3029-10	1/2/3/4
2 x 115	12	175.00	18.34	3	03-3030-10	1/2/3/4
2 x 115	15	140.00	22.92	3	03-3031-10	1/2/3/4
2 x 115	18	116.67	26.25	3	03-3032-10	1/2/3/4
2 x 115	21	100.00	29.56	3	03-3033-10	1/2/3/4
2 x 115	24	87.50	34.55	3	03-3034-10	1/2/3/4
2 x 115	2 x 6	175.00	2 x 10.26	4	03-3035-10	1/2/3/4
2 x 115	2 x 7.5	140.00	2 x 12.03	4	03-3036-10	1/2/3/4
2 x 115	2 x 9	116.67	2 x 14.10	4	03-3037-10	1/2/3/4
2 x 115	2 x 12	87.50	2 x 18.85	4	03-3038-10	1/2/3/4
2 x 115	2 x 15	70.00	2 x 22.92	4	03-3039-10	1/2/3/4

Subject to technical changes / Technische Änderungen vorbehalten!

Mechanical dimensions / Mechanische Abmessungen

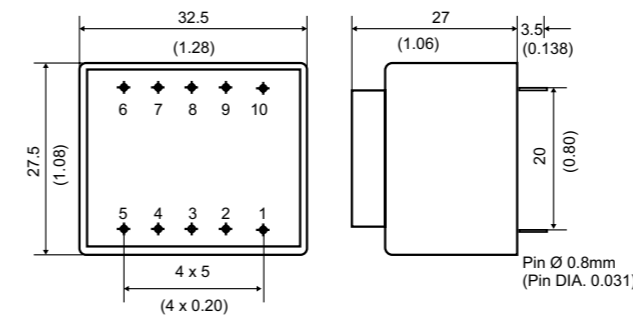

Approvals / Approbationen

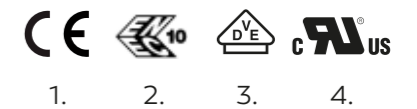

Schematic / Schema



TRANSFORMER EI 30/18 2.30 VA

- Frequency / Frequenz 50/60 Hz
- Potted under vacuum / Vakuumvergossen
- Split-bobbin / Zweikammer-Wicklung
- Temperature class / Temperaturklasse ta 70 °C/F
- Short-circuit-proof / Kurzschlussfest
- Weight / Gewicht 0.112 kg
- Other primary and secondary voltages on request / Weitere Primär- und Sekundärspannungen auf Anfrage
- DIN EN 60335-1 glow wire test / Glühdrahtprüfung



Primary (V) Primär (V)	Secondary (V) Sekundär (V)	mA	No-Load Voltage (V) Leerlaufspannung (V)	Schematic-No. Schema-Nr.	Part.-No. Sachnummer	Approvals Approbationen
115	6	383.33	9.16	1	03-4014-10	1/2/3/4
115	7.5	306.67	12.08	1	03-4015-10	1/2/3/4
115	9	255.56	14.55	1	03-4016-10	1/2/3/4
115	12	191.67	19.65	1	03-4017-10	1/2/3/4
115	15	153.33	23.70	1	03-4018-10	1/2/3/4
115	18	127.78	28.10	1	03-4019-10	1/2/3/4
115	21	109.52	32.60	1	03-4020-10	1/2/3/4
115	24	95.83	38.25	1	03-4021-10	1/2/3/4
115	2 x 6	191.67	2 x 9.60	2	03-4022-10	1/2/3/4
115	2 x 7.5	153.33	2 x 11.85	2	03-4023-10	1/2/3/4
115	2 x 9	127.78	2 x 14.10	2	03-4024-10	1/2/3/4
115	2 x 12	95.83	2 x 19.40	2	03-4025-10	1/2/3/4
115	2 x 15	76.66	2 x 23.60	2	03-4026-10	1/2/3/4

Subject to technical changes / Technische Änderungen vorbehalten!

Mechanical dimensions / Mechanische Abmessungen

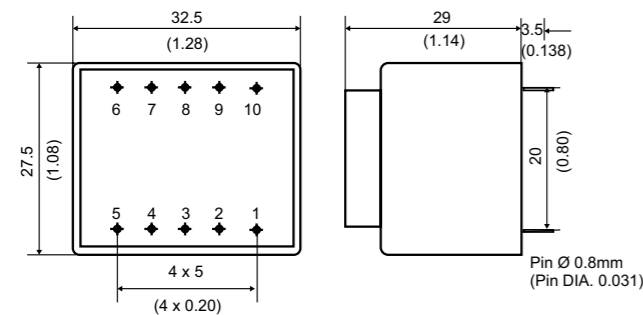

Approvals / Approbationen

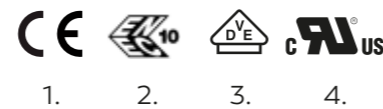

Schematic / Schema

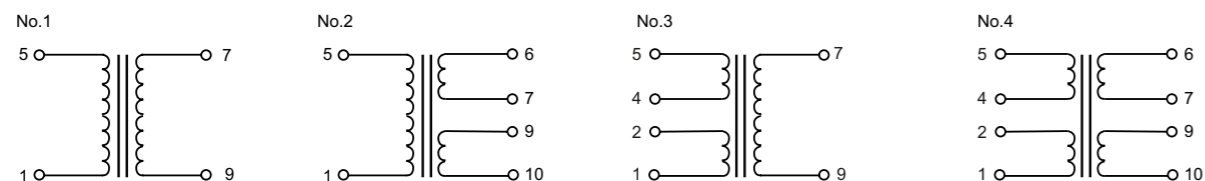

TRANSFORMER EI 30/18 2.30 VA

- Frequency / Frequenz 50/60 Hz
- Potted under vacuum / Vakuumvergossen
- Split-bobbin / Zweikammer-Wicklung
- Temperature class / Temperaturklasse ta 70 °C/F
- Short-circuit-proof / Kurzschlussfest
- Weight / Gewicht 0.112 kg
- Other primary and secondary voltages on request / Weitere Primär- und Sekundärspannungen auf Anfrage
- DIN EN 60335-1 glow wire test / Glühdrahtprüfung



Primary (V) Primär (V)	Secondary (V) Sekundär (V)	mA	No-Load Voltage (V) Leerlaufspannung (V)	Schematic-No. Schema-Nr.	Part.-No. Sachnummer	Approvals Approbationen
230	6	383.33	9.16	1	03-4001-10	1/2/3/4
230	7.5	306.67	12.08	1	03-4002-10	1/2/3/4
230	9	255.56	14.55	1	03-4003-10	1/2/3/4
230	12	191.67	19.65	1	03-4004-10	1/2/3/4
230	15	153.33	23.70	1	03-4005-10	1/2/3/4
230	18	127.78	28.10	1	03-4006-10	1/2/3/4
230	21	109.52	32.60	1	03-4007-10	1/2/3/4
230	24	95.83	38.25	1	03-4008-10	1/2/3/4
230	2 x 6	191.67	2 x 9.60	2	03-4009-10	1/2/3/4
230	2 x 7.5	153.33	2 x 11.85	2	03-4010-10	1/2/3/4
230	2 x 9	127.78	2 x 14.10	2	03-4011-10	1/2/3/4
230	2 x 12	95.83	2 x 19.40	2	03-4012-10	1/2/3/4
230	2 x 15	76.66	2 x 23.60	2	03-4013-10	1/2/3/4

Subject to technical changes / Technische Änderungen vorbehalten!

Mechanical dimensions / Mechanische Abmessungen

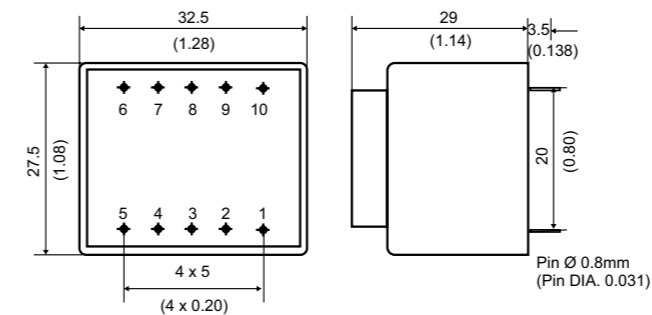

Approvals / Approbationen

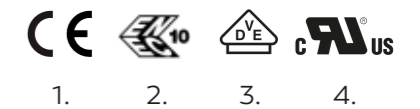

Schematic / Schema



TRANSFORMER EI 30/18 2.30 VA

- Frequency / Frequenz 50/60 Hz
- Potted under vacuum / Vakuumvergossen
- Split-bobbin / Zweikammer-Wicklung
- Temperature class / Temperaturklasse ta 70 °C/F
- Short-circuit-proof / Kurzschlussfest
- Weight / Gewicht 0.112 kg
- Other primary and secondary voltages on request / Weitere Primär- und Sekundärspannungen auf Anfrage
- DIN EN 60335-1 glow wire test / Glühdrahtprüfung



Primary (V) Primär (V)	Secondary (V) Sekundär (V)	mA	No-Load Voltage (V) Leerlaufspannung (V)	Schematic-No. Schema-Nr.	Part.-No. Sachnummer	Approvals Approbationen
2 x 115	6	383.33	9.16	3	03-4027-10	1/2/3/4
2 x 115	7.5	306.67	12.08	3	03-4028-10	1/2/3/4
2 x 115	9	255.56	14.55	3	03-4029-10	1/2/3/4
2 x 115	12	191.67	19.65	3	03-4030-10	1/2/3/4
2 x 115	15	153.33	23.70	3	03-4031-10	1/2/3/4
2 x 115	18	127.78	28.10	3	03-4032-10	1/2/3/4
2 x 115	21	109.52	32.60	3	03-4033-10	1/2/3/4
2 x 115	24	95.83	38.25	3	03-4034-10	1/2/3/4
2 x 115	2 x 6	191.67	2 x 9.60	4	03-4035-10	1/2/3/4
2 x 115	2 x 7.5	153.33	2 x 11.85	4	03-4036-10	1/2/3/4
2 x 115	2 x 9	127.78	2 x 14.10	4	03-4037-10	1/2/3/4
2 x 115	2 x 12	95.83	2 x 19.40	4	03-4038-10	1/2/3/4
2 x 115	2 x 15	76.66	2 x 23.60	4	03-4039-10	1/2/3/4

Subject to technical changes / Technische Änderungen vorbehalten!

Mechanical dimensions / Mechanische Abmessungen

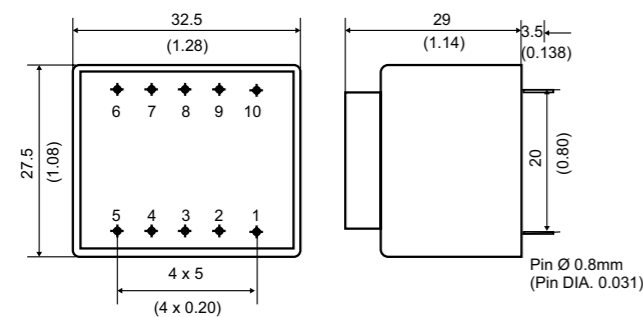

Approvals / Approbationen

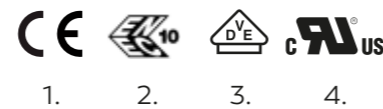

Schematic / Schema

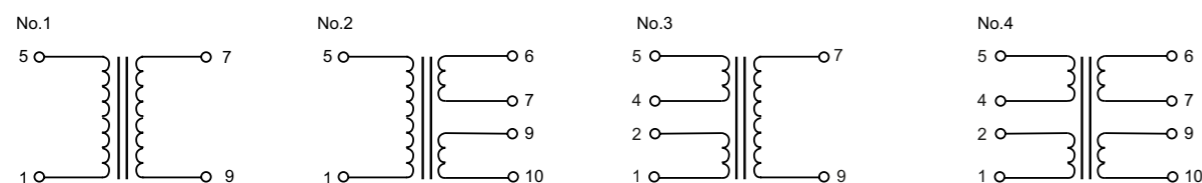

TRANSFORMER EI 30/18 2.80 VA

- Frequency / Frequenz 50/60 Hz
- Potted under vacuum / Vakuumvergossen
- Split-bobbin / Zweikammer-Wicklung
- Temperature class / Temperaturklasse ta 70 °C/F
- Short-circuit-proof / Kurzschlussfest
- Weight / Gewicht 0.139 kg
- Other primary and secondary voltages on request / Weitere Primär- und Sekundärspannungen auf Anfrage
- DIN EN 60335-1 glow wire test / Glühdrahtprüfung



Primary (V) Primär (V)	Secondary (V) Sekundär (V)	mA	No-Load Voltage (V) Leerlaufspannung (V)	Schematic-No. Schema-Nr.	Part.-No. Sachnummer	Approvals Approbationen
115	6	466.67		1	03-5114-10	1/2/3/4
115	7.5	373.33		1	03-5115-10	1/2/3/4
115	9	311.11		1	03-5116-10	1/2/3/4
115	12	233.33		1	03-5117-10	1/2/3/4
115	15	186.67		1	03-5118-10	1/2/3/4
115	18	155.56		1	03-5119-10	1/2/3/4
115	21	133.33		1	03-5120-10	1/2/3/4
115	24	116.67		1	03-5121-10	1/2/3/4
115	2 x 6	233.33		2	03-5122-10	1/2/3/4
115	2 x 7.5	186.66		2	03-5123-10	1/2/3/4
115	2 x 9	155.55		2	03-5124-10	1/2/3/4
115	2 x 12	116.66		2	03-5125-10	1/2/3/4
115	2 x 15	93.33		2	03-5126-10	1/2/3/4

Subject to technical changes / Technische Änderungen vorbehalten!

Mechanical dimensions / Mechanische Abmessungen

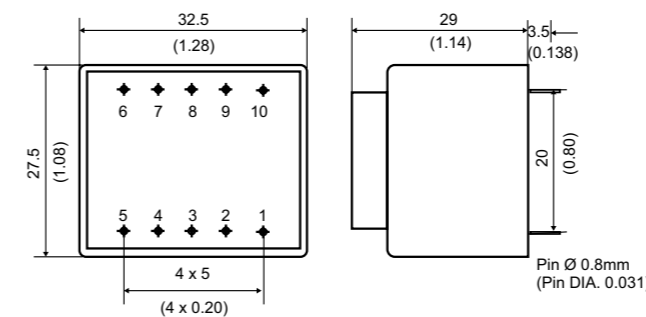

Approvals / Approbationen

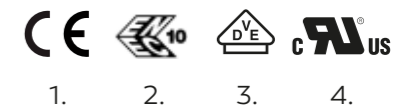

Schematic / Schema



TRANSFORMER EI 30/23 2.80 VA

- Frequency / Frequenz 50/60 Hz
- Potted under vacuum / Vakuumvergossen
- Split-bobbin / Zweikammer-Wicklung
- Temperature class / Temperaturklasse ta 70 °C/F
- Short-circuit-proof / Kurzschlussfest
- Weight / Gewicht 0.139 kg
- Other primary and secondary voltages on request / Weitere Primär- und Sekundärspannungen auf Anfrage
- DIN EN 60335-1 glow wire test / Glühdrahtprüfung



Primary (V) Primär (V)	Secondary (V) Sekundär (V)	mA	No-Load Voltage (V) Leerlaufspannung (V)	Schematic-No. Schema-Nr.	Part.-No. Sachnummer	Approvals Approbationen
230	6	466.67		1	03-5101-10	1/2/3/4
230	7.5	373.33		1	03-5102-10	1/2/3/4
230	9	311.11		1	03-5103-10	1/2/3/4
230	12	233.33		1	03-5104-10	1/2/3/4
230	15	186.67		1	03-5105-10	1/2/3/4
230	18	155.56		1	03-5106-10	1/2/3/4
230	21	133.33		1	03-5107-10	1/2/3/4
230	24	116.67		1	03-5108-10	1/2/3/4
230	2 x 6	233.33		2	03-5109-10	1/2/3/4
230	2 x 7.5	186.66		2	03-5110-10	1/2/3/4
230	2 x 9	155.55		2	03-5111-10	1/2/3/4
230	2 x 12	116.66		2	03-5112-10	1/2/3/4
230	2 x 15	93.33		2	03-5113-10	1/2/3/4

Subject to technical changes / Technische Änderungen vorbehalten!

Mechanical dimensions / Mechanische Abmessungen

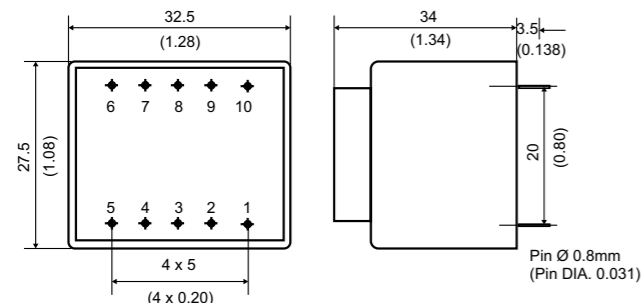

Approvals / Approbationen

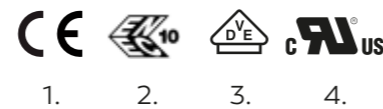

Schematic / Schema

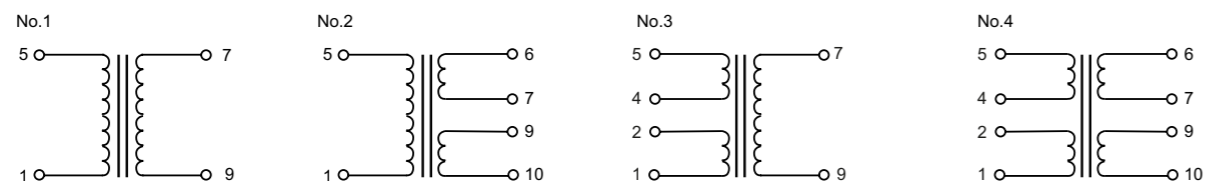

TRANSFORMER EI 30/23 2.80 VA

- Frequency / Frequenz 50/60 Hz
- Potted under vacuum / Vakuumvergossen
- Split-bobbin / Zweikammer-Wicklung
- Temperature class / Temperaturklasse ta 70 °C/F
- Short-circuit-proof / Kurzschlussfest
- Weight / Gewicht 0.139 kg
- Other primary and secondary voltages on request / Weitere Primär- und Sekundärspannungen auf Anfrage
- DIN EN 60335-1 glow wire test / Glühdrahtprüfung



Primary (V) Primär (V)	Secondary (V) Sekundär (V)	mA	No-Load Voltage (V) Leerlaufspannung (V)	Schematic-No. Schema-Nr.	Part.-No. Sachnummer	Approvals Approbationen
2 x 115	6	466.67		3	03-5127-10	1/2/3/4
2 x 115	7.5	373.33		3	03-5128-10	1/2/3/4
2 x 115	9	311.11		3	03-2129-10	1/2/3/4
2 x 115	12	233.33		3	03-5130-10	1/2/3/4
2 x 115	15	186.67		3	03-5131-10	1/2/3/4
2 x 115	18	155.56		3	03-5132-10	1/2/3/4
2 x 115	21	133.33		3	03-5133-10	1/2/3/4
2 x 115	24	116.67		3	03-5134-10	1/2/3/4
2 x 115	2 x 6	233.33		4	03-5135-10	1/2/3/4
2 x 115	2 x 7.5	186.66		4	03-5136-10	1/2/3/4
2 x 115	2 x 9	155.55		4	03-5137-10	1/2/3/4
2 x 115	2 x 12	116.66		4	03-5138-10	1/2/3/4
2 x 115	2 x 15	93.33		4	03-5139-10	1/2/3/4

Subject to technical changes / Technische Änderungen vorbehalten!

Mechanical dimensions / Mechanische Abmessungen

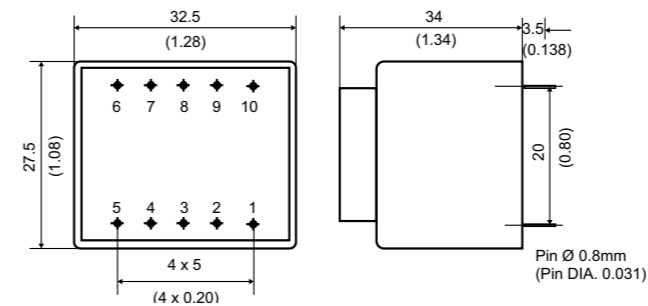

Approvals / Approbationen

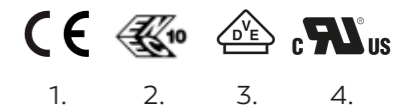

Schematic / Schema



TRANSFORMER EI 38/13.6 4.50 VA

- Frequency / Frequenz 50/60 Hz
- Potted under vacuum / Vakuumvergossen
- Split-bobbin / Zweikammer-Wicklung
- Temperature class / Temperaturklasse ta 70 °C/F
- Short-circuit-proof / Kurzschlussfest
- Weight / Gewicht 0.155 kg
- Other primary and secondary voltages on request / Weitere Primär- und Sekundärspannungen auf Anfrage
- DIN EN 60335-1 glow wire test / Glühdrahtprüfung



Primary (V) Primär (V)	Secondary (V) Sekundär (V)	mA	No-Load Voltage (V) Leerlaufspannung (V)	Schematic-No. Schema-Nr.	Part.-No. Sachnummer	Approvals Approbationen
230	6	750.00	8.78	1	04-1001-11	1/2/3/4
230	7.5	600.00	10.95	1	04-1002-11	1/2/3/4
230	9	500.00	12.88	1	04-1003-11	1/2/3/4
230	12	375.00	18.14	1	04-1004-11	1/2/3/4
230	15	300.00	22.50	1	04-1005-11	1/2/3/4
230	18	250.00	26.30	1	04-1006-11	1/2/3/4
230	21	214.29	30.92	1	04-1007-11	1/2/3/4
230	24	187.50	34.54	1	04-1008-11	1/2/3/4
230	2 x 6	375.00	2 x 87.78	2	04-1009-11	1/2/3/4
230	2 x 7.5	300.00	2 x 11.10	2	04-1010-11	1/2/3/4
230	2 x 9	250.00	2 x 13.10	2	04-1011-11	1/2/3/4
230	2 x 12	187.50	2 x 18.32	2	04-1012-11	1/2/3/4
230	2 x 15	150.00	2 x 22.70	2	04-1013-11	1/2/3/4

Subject to technical changes / Technische Änderungen vorbehalten!

Mechanical dimensions / Mechanische Abmessungen

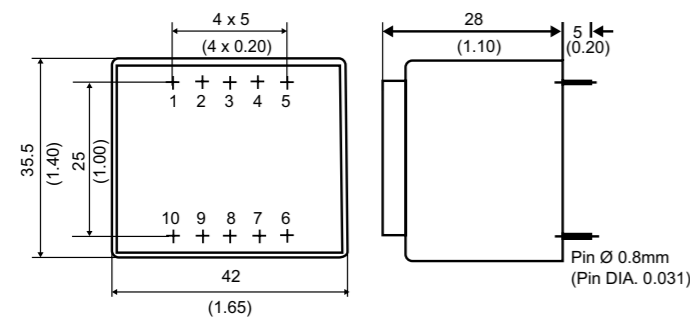

Approvals / Approbationen

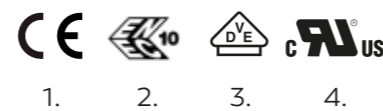

Schematic / Schema

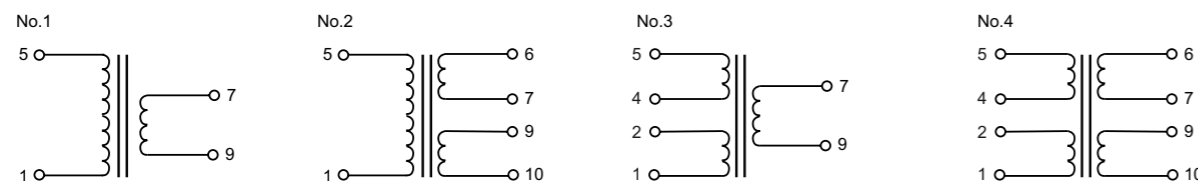

TRANSFORMER EI 38/13.6 4.50 VA

- Frequency / Frequenz 50/60 Hz
- Potted under vacuum / Vakuumvergossen
- Split-bobbin / Zweikammer-Wicklung
- Temperature class / Temperaturklasse ta 70 °C/F
- Short-circuit-proof / Kurzschlussfest
- Weight / Gewicht 0.155 kg
- Other primary and secondary voltages on request / Weitere Primär- und Sekundärspannungen auf Anfrage
- DIN EN 60335-1 glow wire test / Glühdrahtprüfung



Primary (V) Primär (V)	Secondary (V) Sekundär (V)	mA	No-Load Voltage (V) Leerlaufspannung (V)	Schematic-No. Schema-Nr.	Part.-No. Sachnummer	Approvals Approbationen
115	6	750.00	8.78	1	04-1014-11	1/2/3/4
115	7.5	600.00	10.95	1	04-1015-11	1/2/3/4
115	9	500.00	12.88	1	04-1016-11	1/2/3/4
115	12	375.00	18.14	1	04-1017-11	1/2/3/4
115	15	300.00	22.50	1	04-1018-11	1/2/3/4
115	18	250.00	26.30	1	04-1019-11	1/2/3/4
115	21	214.29	30.92	1	04-10120-11	1/2/3/4
115	24	187.50	34.54	1	04-1021-11	1/2/3/4
115	2 x 6	375.00	2 x 87.78	2	04-1022-11	1/2/3/4
115	2 x 7.5	300.00	2 x 11.10	2	04-1023-11	1/2/3/4
115	2 x 9	250.00	2 x 13.10	2	04-1024-11	1/2/3/4
115	2 x 12	187.50	2 x 18.32	2	04-1025-11	1/2/3/4
115	2 x 15	150.00	2 x 22.70	2	04-1026-11	1/2/3/4

Subject to technical changes / Technische Änderungen vorbehalten!

Mechanical dimensions / Mechanische Abmessungen

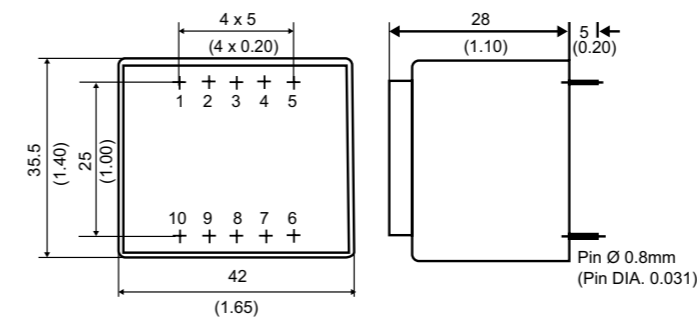

Approvals / Approbationen

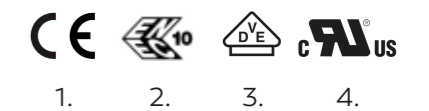

Schematic / Schema



TRANSFORMER EI 38/13.6 4.50 VA

- Frequency / Frequenz 50/60 Hz
- Potted under vacuum / Vakuumvergossen
- Split-bobbin / Zweikammer-Wicklung
- Temperature class / Temperaturklasse ta 70 °C/F
- Short-circuit-proof / Kurzschlussfest
- Weight / Gewicht 0.155 kg
- Other primary and secondary voltages on request / Weitere Primär- und Sekundärspannungen auf Anfrage
- DIN EN 60335-1 glow wire test / Glühdrahtprüfung



Primary (V) Primär (V)	Secondary (V) Sekundär (V)	mA	No-Load Voltage (V) Leerlaufspannung (V)	Schematic-No. Schema-Nr.	Part.-No. Sachnummer	Approvals Approbationen
2 x 115	6	750.00	8.78	3	04-1027-11	1/2/3/4
2 x 115	7.5	600.00	10.95	3	04-1028-11	1/2/3/4
2 x 115	9	500.00	12.88	3	04-1029-11	1/2/3/4
2 x 115	12	375.00	18.14	3	04-1030-11	1/2/3/4
2 x 115	15	300.00	22.50	3	04-1031-11	1/2/3/4
2 x 115	18	250.00	26.30	3	04-1032-11	1/2/3/4
2 x 115	21	214.29	30.92	3	04-1033-11	1/2/3/4
2 x 115	24	187.50	34.54	3	04-1034-11	1/2/3/4
2 x 115	2 x 6	375.00	2 x 87.78	4	04-1035-11	1/2/3/4
2 x 115	2 x 7.5	300.00	2 x 11.10	4	04-1036-11	1/2/3/4
2 x 115	2 x 9	250.00	2 x 13.10	4	04-1037-11	1/2/3/4
2 x 115	2 x 12	187.50	2 x 18.32	4	04-1038-11	1/2/3/4
2 x 115	2 x 15	150.00	2 x 22.70	4	04-1039-11	1/2/3/4

Subject to technical changes / Technische Änderungen vorbehalten!

Mechanical dimensions / Mechanische Abmessungen

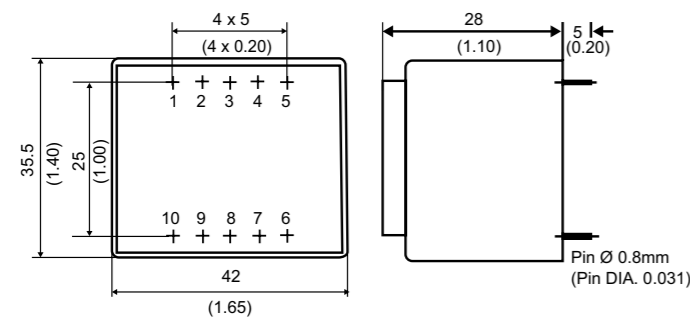

Approvals / Approbationen

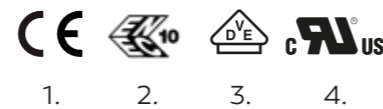

Schematic / Schema

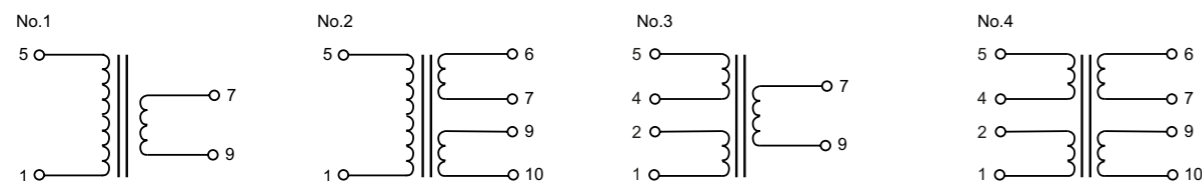

TRANSFORMER EI 38/13.6 4.50 VA

- Frequency / Frequenz 50/60 Hz
- Potted under vacuum / Vakuumvergossen
- Split-bobbin / Zweikammer-Wicklung
- Temperature class / Temperaturklasse ta 70 °C/F
- Short-circuit-proof / Kurzschlussfest
- Weight / Gewicht 0.155 kg
- Other primary and secondary voltages on request / Weitere Primär- und Sekundärspannungen auf Anfrage
- DIN EN 60335-1 glow wire test / Glühdrahtprüfung



Primary (V) Primär (V)	Secondary (V) Sekundär (V)	mA	No-Load Voltage (V) Leerlaufspannung (V)	Schematic-No. Schema-Nr.	Part.-No. Sachnummer	Approvals Approbationen
115	6	750.00	8.78	1	04-1014-14	1/2/3/4
115	7.5	600.00	10.95	1	04-1015-14	1/2/3/4
115	9	500.00	12.88	1	04-1016-14	1/2/3/4
115	12	375.00	18.14	1	04-1017-14	1/2/3/4
115	15	300.00	22.50	1	04-1018-14	1/2/3/4
115	18	250.00	26.30	1	04-1019-14	1/2/3/4
115	21	214.29	30.92	1	04-1020-14	1/2/3/4
115	24	187.50	34.54	1	04-1021-14	1/2/3/4
115	2 x 6	375.00	2 x 87.78	2	04-1022-14	1/2/3/4
115	2 x 7.5	300.00	2 x 11.10	2	04-1023-14	1/2/3/4
115	2 x 9	250.00	2 x 13.10	2	04-1024-14	1/2/3/4
115	2 x 12	187.50	2 x 18.32	2	04-1025-14	1/2/3/4
115	2 x 15	150.00	2 x 22.70	2	04-1026-14	1/2/3/4

Subject to technical changes / Technische Änderungen vorbehalten!

Mechanical dimensions / Mechanische Abmessungen

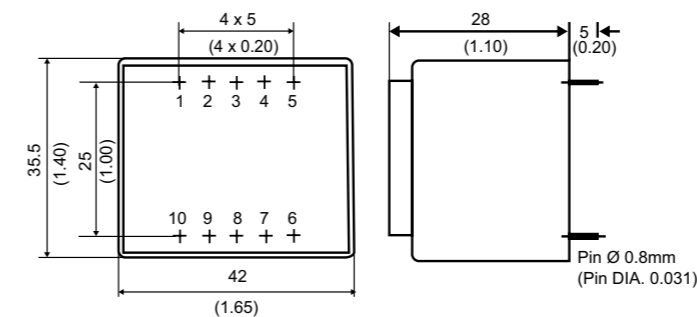

Approvals / Approbationen

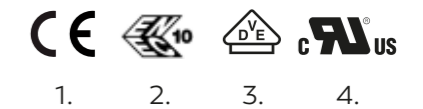

Schematic / Schema



TRANSFORMER EI 38/13.6 4.50 VA

- Frequency / Frequenz 50/60 Hz
- Potted under vacuum / Vakuumvergossen
- Split-bobbin / Zweikammer-Wicklung
- Temperature class / Temperaturklasse ta 70 °C/F
- Short-circuit-proof / Kurzschlussfest
- Weight / Gewicht 0.155 kg
- Other primary and secondary voltages on request / Weitere Primär- und Sekundärspannungen auf Anfrage
- DIN EN 60335-1 glow wire test / Glühdrahtprüfung



Primary (V) Primär (V)	Secondary (V) Sekundär (V)	mA	No-Load Voltage (V) Leerlaufspannung (V)	Schematic-No. Schema-Nr.	Part.-No. Sachnummer	Approvals Approbationen
230	6	750.00	8.78	1	04-1001-14	1/2/3/4
230	7.5	600.00	10.95	1	04-1002-14	1/2/3/4
230	9	500.00	12.88	1	04-1003-14	1/2/3/4
230	12	375.00	18.14	1	04-1004-14	1/2/3/4
230	15	300.00	22.50	1	04-1005-14	1/2/3/4
230	18	250.00	26.30	1	04-1006-14	1/2/3/4
230	21	214.29	30.92	1	04-1007-14	1/2/3/4
230	24	187.50	34.54	1	04-1008-14	1/2/3/4
230	2 x 6	375.00	2 x 87.78	2	04-1009-14	1/2/3/4
230	2 x 7.5	300.00	2 x 11.10	2	04-1010-14	1/2/3/4
230	2 x 9	250.00	2 x 13.10	2	04-1011-14	1/2/3/4
230	2 x 12	187.50	2 x 18.32	2	04-1012-14	1/2/3/4
230	2 x 15	150.00	2 x 22.70	2	04-1013-14	1/2/3/4

Subject to technical changes / Technische Änderungen vorbehalten!

Mechanical dimensions / Mechanische Abmessungen

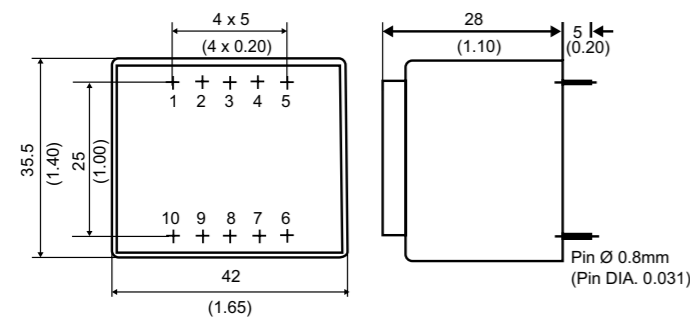

Approvals / Approbationen

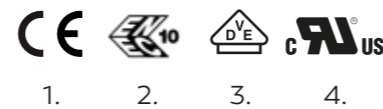

Schematic / Schema

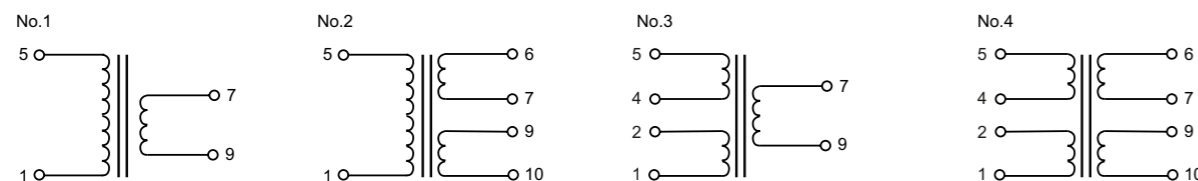

TRANSFORMER EI 38/13.6 4.50 VA

- Frequency / Frequenz 50/60 Hz
- Potted under vacuum / Vakuumvergossen
- Split-bobbin / Zweikammer-Wicklung
- Temperature class / Temperaturklasse ta 70 °C/F
- Short-circuit-proof / Kurzschlussfest
- Weight / Gewicht 0.155 kg
- Other primary and secondary voltages on request / Weitere Primär- und Sekundärspannungen auf Anfrage
- DIN EN 60335-1 glow wire test / Glühdrahtprüfung



Primary (V) Primär (V)	Secondary (V) Sekundär (V)	mA	No-Load Voltage (V) Leerlaufspannung (V)	Schematic-No. Schema-Nr.	Part.-No. Sachnummer	Approvals Approbationen
2 x 115	6	750.00	8.78	3	04-1027-14	1/2/3/4
2 x 115	7.5	600.00	10.95	3	04-1028-14	1/2/3/4
2 x 115	9	500.00	12.88	3	04-1029-14	1/2/3/4
2 x 115	12	375.00	18.14	3	04-1030-14	1/2/3/4
2 x 115	15	300.00	22.50	3	04-1031-14	1/2/3/4
2 x 115	18	250.00	26.30	3	04-1032-14	1/2/3/4
2 x 115	21	214.29	30.92	3	04-1033-14	1/2/3/4
2 x 115	24	187.50	34.54	3	04-1034-14	1/2/3/4
2 x 115	2 x 6	375.00	2 x 87.78	3	04-1035-14	1/2/3/4
2 x 115	2 x 7.5	300.00	2 x 11.10	4	04-1036-14	1/2/3/4
2 x 115	2 x 9	250.00	2 x 13.10	4	04-1037-14	1/2/3/4
2 x 115	2 x 12	187.50	2 x 18.32	4	04-1038-14	1/2/3/4
2 x 115	2 x 15	150.00	2 x 22.70	4	04-1039-14	1/2/3/4

Subject to technical changes / Technische Änderungen vorbehalten!

Mechanical dimensions / Mechanische Abmessungen

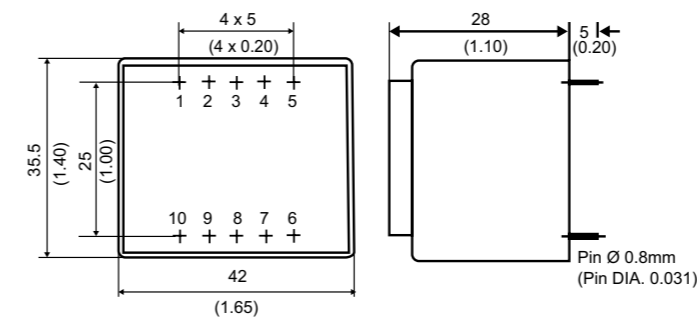

Approvals / Approbationen

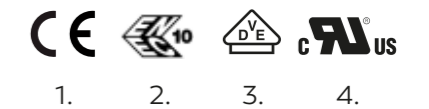

Schematic / Schema



TRANSFORMER EI 42/14.8 6.00 VA

- Frequency / Frequenz 50/60 Hz
- Potted under vacuum / Vakuumvergossen
- Split-bobbin / Zweikammer-Wicklung
- Temperature class / Temperaturklasse ta 70 °C/F
- Short-circuit-proof / Kurzschlussfest
- Weight / Gewicht 0.200 kg
- Other primary and secondary voltages on request / Weitere Primär- und Sekundärspannungen auf Anfrage
- DIN EN 60335-1 glow wire test / Glühdrahtprüfung



Primary (V) Primär (V)	Secondary (V) Sekundär (V)	mA	No-Load Voltage (V) Leerlaufspannung (V)	Schematic-No. Schema-Nr.	Part.-No. Sachnummer	Approvals Approbationen
115	6	1000.00	8.28	1	05-1014-14	1/2/3
115	7.5	800.00	10.33	1	05-1015-14	1/2/3
115	9	666.67	12.15	1	05-1016-14	1/2/3
115	12	500.00	17.11	1	05-1017-14	1/2/3
115	15	400.00	20.70	1	05-1018-14	1/2/3
115	18	333.33	24.85	1	05-1019-14	1/2/3
115	21	285.71	28.95	1	05-1020-14	1/2/3
115	24	250.00	33.10	1	05-1021-14	1/2/3
115	2 x 6	500.00	2 x 8.45	2	05-1022-14	1/2/3
115	2 x 7.5	400.00	2 x 10.45	2	05-1023-14	1/2/3
115	2 x 9	333.33	2 x 12.78	2	05-1024-14	1/2/3
115	2 x 12	250.00	2 x 16.90	2	05-1025-14	1/2/3
115	2 x 15	200.00	2 x 21.00	2	05-1026-14	1/2/3

Subject to technical changes / Technische Änderungen vorbehalten!

Mechanical dimensions / Mechanische Abmessungen

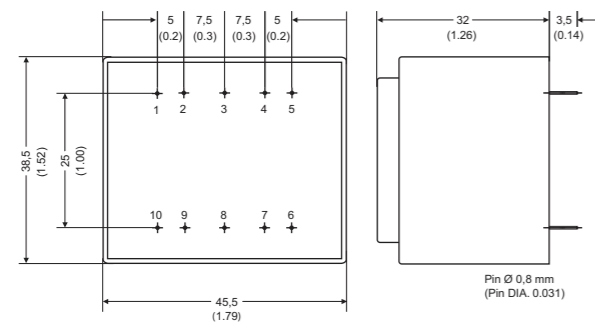

Approvals / Approbationen

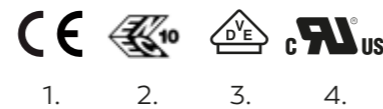

Schematic / Schema

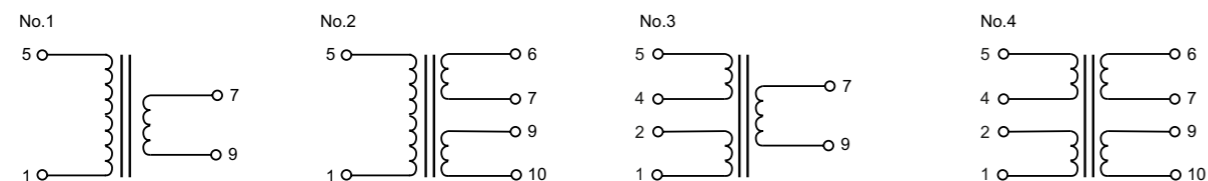

TRANSFORMER EI 42/14.8 6.00 VA

- Frequency / Frequenz 50/60 Hz
- Potted under vacuum / Vakuumvergossen
- Split-bobbin / Zweikammer-Wicklung
- Temperature class / Temperaturklasse ta 70 °C/F
- Short-circuit-proof / Kurzschlussfest
- Weight / Gewicht 0.200 kg
- Other primary and secondary voltages on request / Weitere Primär- und Sekundärspannungen auf Anfrage
- DIN EN 60335-1 glow wire test / Glühdrahtprüfung



Primary (V) Primär (V)	Secondary (V) Sekundär (V)	mA	No-Load Voltage (V) Leerlaufspannung (V)	Schematic-No. Schema-Nr.	Part.-No. Sachnummer	Approvals Approbationen
230	6	1000.00	8.28	1	05-1001-14	1/2/3
230	7.5	800.00	10.33	1	05-1002-14	1/2/3
230	9	666.67	12.15	1	05-1003-14	1/2/3
230	12	500.00	17.11	1	05-1004-14	1/2/3
230	15	400.00	20.70	1	05-1005-14	1/2/3
230	18	333.33	24.85	1	05-1006-14	1/2/3
230	21	285.71	28.95	1	05-1007-14	1/2/3
230	24	250.00	33.10	1	05-1008-14	1/2/3
230	2 x 6	500.00	2 x 8.45	2	05-1009-14	1/2/3
230	2 x 7.5	400.00	2 x 10.45	2	05-1010-14	1/2/3
230	2 x 9	333.33	2 x 12.78	2	05-1011-14	1/2/3
230	2 x 12	250.00	2 x 16.90	2	05-1012-14	1/2/3
230	2 x 15	200.00	2 x 21.00	2	05-1013-14	1/2/3

Subject to technical changes / Technische Änderungen vorbehalten!

Mechanical dimensions / Mechanische Abmessungen

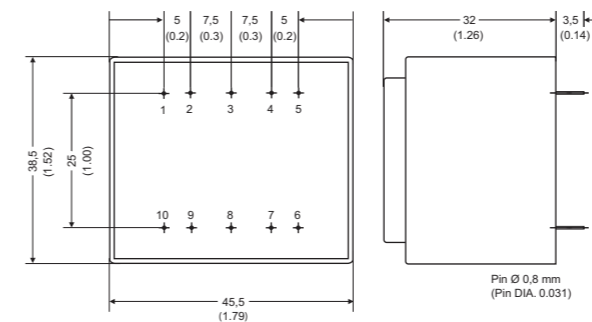

Approvals / Approbationen

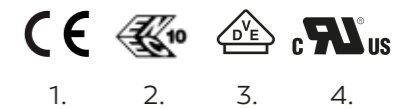

Schematic / Schema



TRANSFORMER EI 42/14.8 6.00 VA

- Frequency / Frequenz 50/60 Hz
- Potted under vacuum / Vakuumvergossen
- Split-bobbin / Zweikammer-Wicklung
- Temperature class / Temperaturklasse ta 70 °C/F
- Short-circuit-proof / Kurzschlussfest
- Weight / Gewicht 0.200 kg
- Other primary and secondary voltages on request / Weitere Primär- und Sekundärspannungen auf Anfrage
- DIN EN 60335-1 glow wire test / Glühdrahtprüfung



TRANSFORMER EI 48/16.8 10.00 VA

- Frequency / Frequenz 50/60 Hz
- Potted under vacuum / Vakuumvergossen
- Split-bobbin / Zweikammer-Wicklung
- Temperature class / Temperaturklasse ta 70 °C/F
- Short-circuit-proof / Kurzschlussfest
- Weight / Gewicht 0.295 kg
- Other primary and secondary voltages on request / Weitere Primär- und Sekundärspannungen auf Anfrage
- DIN EN 60335-1 glow wire test / Glühdrahtprüfung



Primary (V) Primär (V)	Secondary (V) Sekundär (V)	mA	No-Load Voltage (V) Leerlaufspannung (V)	Schematic-No. Schema-Nr.	Part.-No. Sachnummer	Approvals Approbationen
2 x 115	6	1000.00	8.28	3	05-1027-14	1/2/3/4
2 x 115	7.5	800.00	10.33	3	05-1028-14	1/2/3/4
2 x 115	9	666.67	12.15	3	05-1029-14	1/2/3/4
2 x 115	12	500.00	17.11	3	05-1030-14	1/2/3/4
2 x 115	15	400.00	20.70	3	05-1031-14	1/2/3/4
2 x 115	18	333.33	24.85	3	05-1032-14	1/2/3/4
2 x 115	21	285.71	28.95	3	05-1033-14	1/2/3/4
2 x 115	24	250.00	33.10	3	05-1034-14	1/2/3/4
2 x 115	2 x 6	500.00	2 x 8.45	4	05-1035-14	1/2/3/4
2 x 115	2 x 7.5	400.00	2 x 10.45	4	05-1036-14	1/2/3/4
2 x 115	2 x 9	333.33	2 x 12.78	4	05-1037-14	1/2/3/4
2 x 115	2 x 12	250.00	2 x 16.90	4	05-1038-14	1/2/3/4
2 x 115	2 x 15	200.00	2 x 21.00	4	05-1039-14	1/2/3/4

Subject to technical changes / Technische Änderungen vorbehalten!

Primary (V) Primär (V)	Secondary (V) Sekundär (V)	mA	No-Load Voltage (V) Leerlaufspannung (V)	Schematic-No. Schema-Nr.	Part.-No. Sachnummer	Approvals Approbationen
115	6	1666.67	7.98	1	06-1014-14	1/2/3/4
115	7.5	1333.33	10.00	1	06-1015-14	1/2/3/4
115	9	111.11	11.95	1	06-1016-14	1/2/3/4
115	12	833.33	15.94	1	06-1017-14	1/2/3/4
115	15	666.67	19.90	1	06-1018-14	1/2/3/4
115	18	555.56	24.10	1	06-1019-14	1/2/3/4
115	21	476.19	28.10	1	06-1020-14	1/2/3/4
115	24	416.67	32.00	1	06-1021-14	1/2/3/4
115	2 x 6	833.33	2 x 8.00	2	06-1022-14	1/2/3/4
115	2 x 7.5	666.67	2 x 10.00	2	06-1023-14	1/2/3/4
115	2 x 9	555.56	2 x 12.05	2	06-1024-14	1/2/3/4
115	2 x 12	416.67	2 x 15.95	2	06-1025-14	1/2/3/4
115	2 x 15	333.33	2 x 20.00	2	06-1026-14	1/2/3/4

Subject to technical changes / Technische Änderungen vorbehalten!

Mechanical dimensions / Mechanische Abmessungen

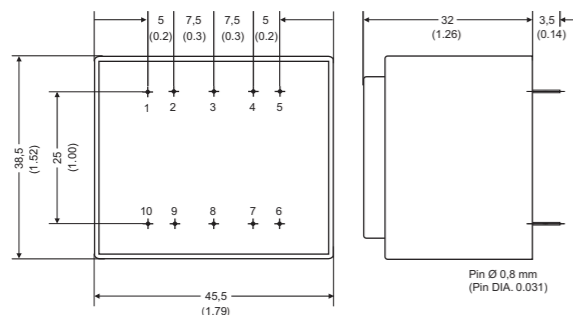

Approvals / Approbationen

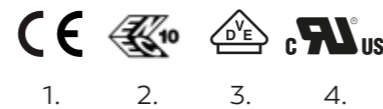

Schematic / Schema

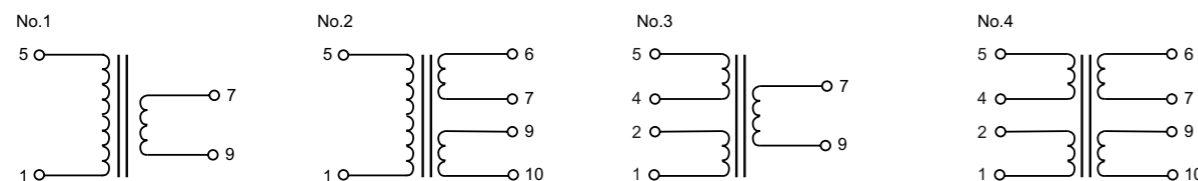

Mechanical dimensions / Mechanische Abmessungen

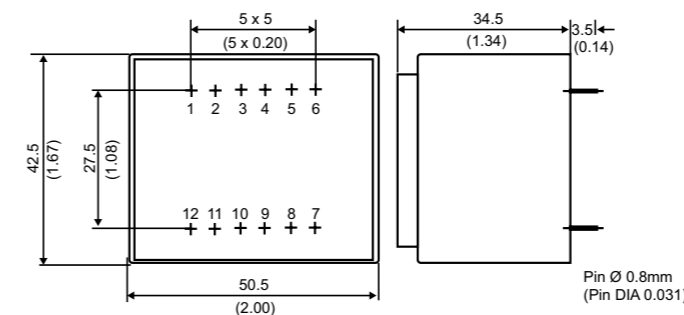

Approvals / Approbationen

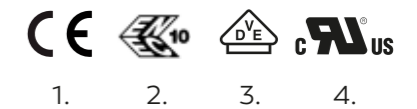

Schematic / Schema

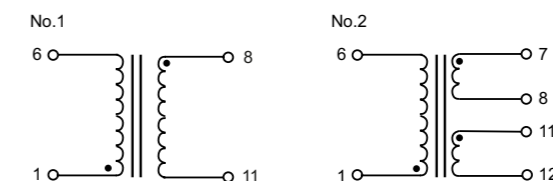

TRANSFORMER EI 48/16.8 10.00 VA

- Frequency / Frequenz 50/60 Hz
- Potted under vacuum / Vakuumvergossen
- Split-bobbin / Zweikammer-Wicklung
- Temperature class / Temperaturklasse ta 70 °C/F
- Short-circuit-proof / Kurzschlussfest
- Weight / Gewicht 0.295 kg
- Other primary and secondary voltages on request / Weitere Primär- und Sekundärspannungen auf Anfrage
- DIN EN 60335-1 glow wire test / Glühdrahtprüfung



TRANSFORMER EI 48/16.8 10.00 VA

- Frequency / Frequenz 50/60 Hz
- Potted under vacuum / Vakuumvergossen
- Split-bobbin / Zweikammer-Wicklung
- Temperature class / Temperaturklasse ta 70 °C/F
- Short-circuit-proof / Kurzschlussfest
- Weight / Gewicht 0.295 kg
- Other primary and secondary voltages on request / Weitere Primär- und Sekundärspannungen auf Anfrage
- DIN EN 60335-1 glow wire test / Glühdrahtprüfung



Primary (V) Primär (V)	Secondary (V) Sekundär (V)	mA	No-Load Voltage (V) Leerlaufspannung (V)	Schematic-No. Schema-Nr.	Part.-No. Sachnummer	Approvals Approbationen
230	6	1666.67	7.98	1	06-1001-14	1/2/3/4
230	7.5	1333.33	10.00	1	06-1002-14	1/2/3/4
230	9	111.11	11.95	1	06-1003-14	1/2/3/4
230	12	833.33	15.94	1	06-1004-14	1/2/3/4
230	15	666.67	19.90	1	06-1005-14	1/2/3/4
230	18	555.56	24.10	1	06-1006-14	1/2/3/4
230	21	476.19	28.10	1	06-1007-14	1/2/3/4
230	24	416.67	32.00	1	06-1008-14	1/2/3/4
230	2 x 6	833.33	2 x 8.00	2	06-1009-14	1/2/3/4
230	2 x 7.5	666.67	2 x 10.00	2	06-1010-14	1/2/3/4
230	2 x 9	555.56	2 x 12.05	2	06-1011-14	1/2/3/4
230	2 x 12	416.67	2 x 15.95	2	06-1012-14	1/2/3/4
230	2 x 15	333.33	2 x 20.00	2	06-1013-14	1/2/3/4

Subject to technical changes / Technische Änderungen vorbehalten!

Primary (V) Primär (V)	Secondary (V) Sekundär (V)	mA	No-Load Voltage (V) Leerlaufspannung (V)	Schematic-No. Schema-Nr.	Part.-No. Sachnummer	Approvals Approbationen
2 x 115	6	1666.67	7.98	3	06-1027-14	1/2/3/4
2 x 115	7.5	1333.33	10.00	3	06-1028-14	1/2/3/4
2 x 115	9	111.11	11.95	3	06-1029-14	1/2/3/4
2 x 115	12	833.33	15.94	3	06-1030-14	1/2/3/4
2 x 115	15	666.67	19.90	3	06-1031-14	1/2/3/4
2 x 115	18	555.56	24.10	3	06-1032-14	1/2/3/4
2 x 115	21	476.19	28.10	3	06-1033-14	1/2/3/4
2 x 115	24	416.67	32.00	3	06-1034-14	1/2/3/4
2 x 115	2 x 6	833.33	2 x 8.00	4	06-1035-14	1/2/3/4
2 x 115	2 x 7.5	666.67	2 x 10.00	4	06-1036-14	1/2/3/4
2 x 115	2 x 9	555.56	2 x 12.05	4	06-1037-14	1/2/3/4
2 x 115	2 x 12	416.67	2 x 15.95	4	06-1038-14	1/2/3/4
2 x 115	2 x 15	333.33	2 x 20.00	4	06-1039-14	1/2/3/4

Subject to technical changes / Technische Änderungen vorbehalten!

Mechanical dimensions / Mechanische Abmessungen

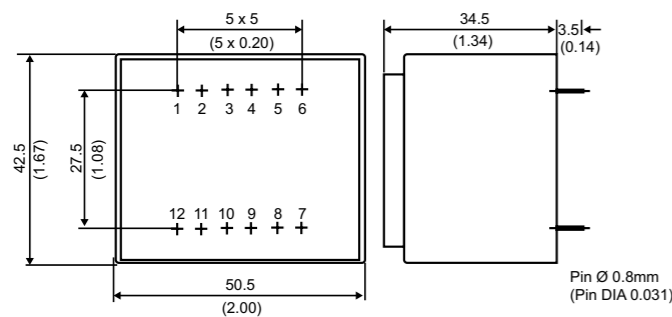

Approvals / Approbationen

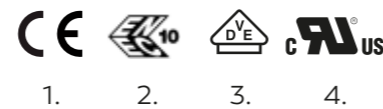

1. 2. 3. 4.

Schematic / Schema

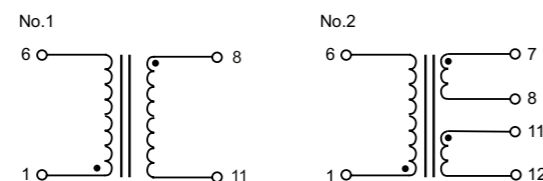

Mechanical dimensions / Mechanische Abmessungen

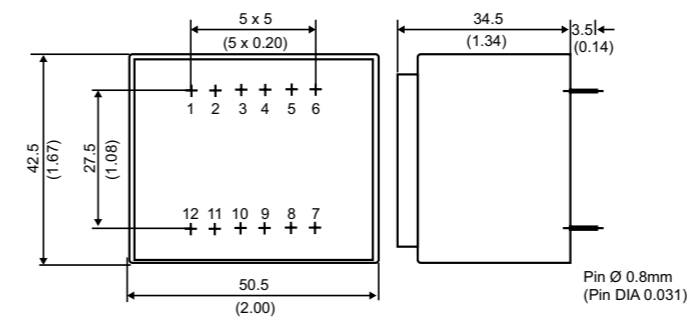

Approvals / Approbationen

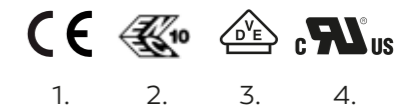

1. 2. 3. 4.

Schematic / Schema

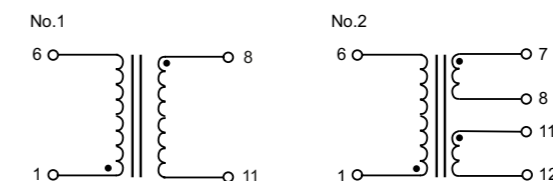

TRANSFORMER EI 48/16.8 10.00 VA

- Frequency / Frequenz 50/60 Hz
- Potted under vacuum / Vakuumvergossen
- Split-bobbin / Zweikammer-Wicklung
- Temperature class / Temperaturklasse ta 70 °C/F
- Short-circuit-proof / Kurzschlussfest
- Weight / Gewicht 0.295 kg
- Other primary and secondary voltages on request / Weitere Primär- und Sekundärspannungen auf Anfrage
- DIN EN 60335-1 glow wire test / Glühdrahtprüfung



TRANSFORMER EI 48/16.8 10.00 VA

- Frequency / Frequenz 50/60 Hz
- Potted under vacuum / Vakuumvergossen
- Split-bobbin / Zweikammer-Wicklung
- Temperature class / Temperaturklasse ta 70 °C/F
- Short-circuit-proof / Kurzschlussfest
- Weight / Gewicht 0.295 kg
- Other primary and secondary voltages on request / Weitere Primär- und Sekundärspannungen auf Anfrage
- DIN EN 60335-1 glow wire test / Glühdrahtprüfung



Primary (V) Primär (V)	Secondary (V) Sekundär (V)	mA	No-Load Voltage (V) Leerlaufspannung (V)	Schematic-No. Schema-Nr.	Part.-No. Sachnummer	Approvals Approbationen
115	6	1666.67	7.98	1	06-1114-14	1/2/3/4
115	7.5	1333.33	10.00	1	06-1115-14	1/2/3/4
115	9	111.11	11.95	1	06-1116-14	1/2/3/4
115	12	833.33	15.94	1	06-1117-14	1/2/3/4
115	15	666.67	19.90	1	06-1118-14	1/2/3/4
115	18	555.56	24.10	1	06-1119-14	1/2/3/4
115	21	476.19	28.10	1	06-1120-14	1/2/3/4
115	24	416.67	32.00	1	06-1121-14	1/2/3/4
115	2 x 6	833.33	2 x 8.00	2	06-1122-14	1/2/3/4
115	2 x 7.5	666.67	2 x 10.00	2	06-1123-14	1/2/3/4
115	2 x 9	555.56	2 x 12.05	2	06-1124-14	1/2/3/4
115	2 x 12	416.67	2 x 15.95	2	06-1125-14	1/2/3/4
115	2 x 15	333.33	2 x 20.00	2	06-1126-14	1/2/3/4

Subject to technical changes / Technische Änderungen vorbehalten!

Primary (V) Primär (V)	Secondary (V) Sekundär (V)	mA	No-Load Voltage (V) Leerlaufspannung (V)	Schematic-No. Schema-Nr.	Part.-No. Sachnummer	Approvals Approbationen
230	6	1666.67	7.98	1	06-1101-14	1/2/3/4
230	7.5	1333.33	10.00	1	06-1102-14	1/2/3/4
230	9	111.11	11.95	1	06-1103-14	1/2/3/4
230	12	833.33	15.94	1	06-1104-14	1/2/3/4
230	15	666.67	19.90	1	06-1105-14	1/2/3/4
230	18	555.56	24.10	1	06-1106-14	1/2/3/4
230	21	476.19	28.10	1	06-1107-14	1/2/3/4
230	24	416.67	32.00	1	06-1108-14	1/2/3/4
230	2 x 6	833.33	2 x 8.00	2	06-1109-14	1/2/3/4
230	2 x 7.5	666.67	2 x 10.00	2	06-1110-14	1/2/3/4
230	2 x 9	555.56	2 x 12.05	2	06-1111-14	1/2/3/4
230	2 x 12	416.67	2 x 15.95	2	06-1112-14	1/2/3/4
230	2 x 15	333.33	2 x 20.00	2	06-1113-14	1/2/3/4

Subject to technical changes / Technische Änderungen vorbehalten!

Mechanical dimensions / Mechanische Abmessungen

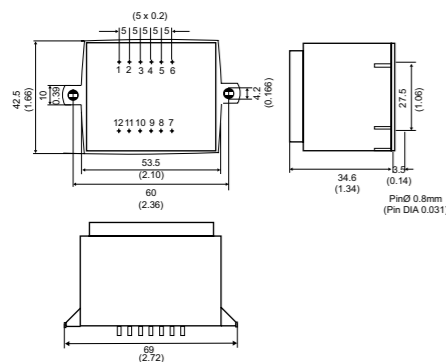

Schematic / Schema

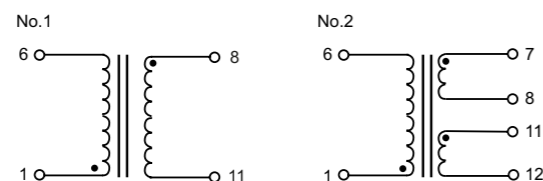

Approvals / Approbationen

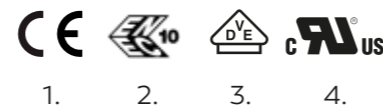

Mechanical dimensions / Mechanische Abmessungen

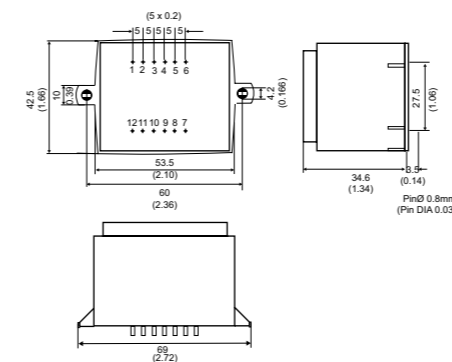

Schematic / Schema

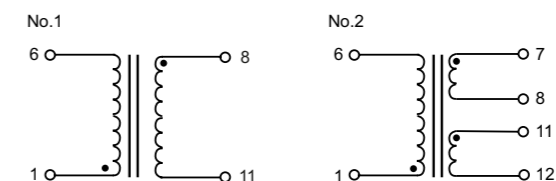

Approvals / Approbationen

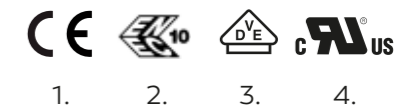

TRANSFORMER EI 54/18.8 16.00 VA

TRANSFORMER EI 54/18.8 16.00 VA

- Frequency / Frequenz 50/60 Hz
- Potted under vacuum / Vakuumvergossen
- Split-bobbin / Zweikammer-Wicklung
- Temperature class / Temperaturklasse ta 70 °C/F
- Short-circuit-proof / Kurzschlussfest
- Weight / Gewicht 0.295 kg
- Other primary and secondary voltages on request / Weitere Primär- und Sekundärspannungen auf Anfrage
- DIN EN 60335-1 glow wire test / Glühdrahtprüfung

- Frequency / Frequenz 50/60 Hz
- Potted under vacuum / Vakuumvergossen
- Split-bobbin / Zweikammer-Wicklung
- Temperature class / Temperaturklasse ta 70 °C/F
- Short-circuit-proof / Kurzschlussfest
- Weight / Gewicht 0.295 kg
- Other primary and secondary voltages on request / Weitere Primär- und Sekundärspannungen auf Anfrage
- DIN EN 60335-1 glow wire test / Glühdrahtprüfung

Primary (V) Primär (V)	Secondary (V) Sekundär (V)	mA	No-Load Voltage (V) Leerlaufspannung (V)	Schematic-No. Schema-Nr.	Part.-No. Sachnummer	Approvals Approbationen
115	6	2666.67		1	07-1014-14	1/4
115	7.5	2133.33		1	07-1015-14	1/4
115	9	1777.78		1	07-1016-14	1/4
115	12	1333.33		1	07-1017-14	1/4
115	15	1066.67		1	07-1018-14	1/4
115	18	888.89		1	07-1019-14	1/4
115	21	761.90		1	07-1020-14	1/4
115	24	666.67		1	07-1021-14	1/4
115	2 x 6	1333.33		2	07-1022-14	1/4
115	2 x 7.5	1066.67		2	07-1023-14	1/4
115	2 x 9	888.89		2	07-1024-14	1/4
115	2 x 12	666.67		2	07-1025-14	1/4
115	2 x 15	533.33		2	07-1026-14	1/4

Primary (V) Primär (V)	Secondary (V) Sekundär (V)	mA	No-Load Voltage (V) Leerlaufspannung (V)	Schematic-No. Schema-Nr.	Part.-No. Sachnummer	Approvals Approbationen
230	6	2666.67		1	07-1001-14	1/4
230	7.5	2133.33		1	07-1002-14	1/4
230	9	1777.78		1	07-1003-14	1/4
230	12	1333.33		1	07-1004-14	1/4
230	15	1066.67		1	07-1005-14	1/4
230	18	888.89		1	07-1006-14	1/4
230	21	761.90		1	07-1007-14	1/4
230	24	666.67		1	07-1008-14	1/4
230	2 x 6	1333.33		2	07-1009-14	1/4
230	2 x 7.5	1066.67		2	07-1010-14	1/4
230	2 x 9	888.89		2	07-1011-14	1/4
230	2 x 12	666.67		2	07-1012-14	1/4
230	2 x 15	533.33		2	07-1013-14	1/4

Subject to technical changes / Technische Änderungen vorbehalten!

Subject to technical changes / Technische Änderungen vorbehalten!

Mechanical dimensions / Mechanische Abmessungen

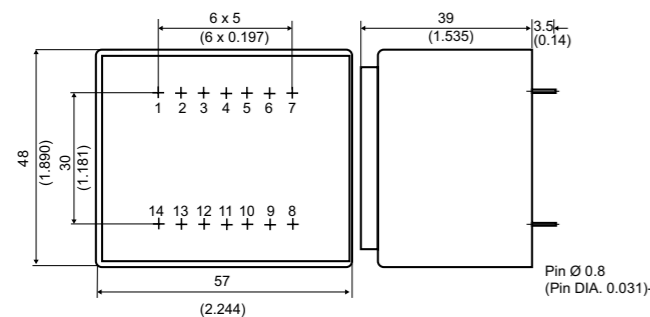

Approvals / Approbationen

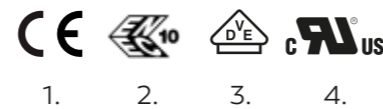

Mechanical dimensions / Mechanische Abmessungen

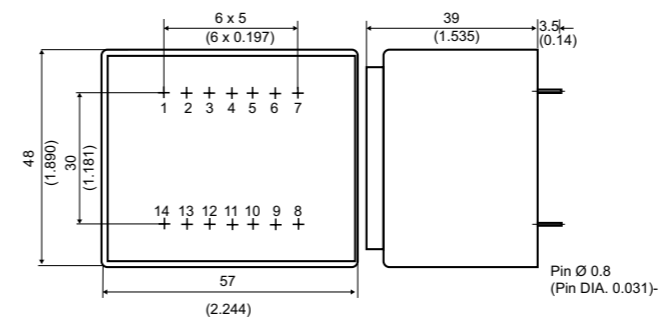

Approvals / Approbationen

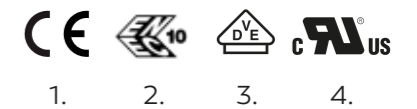

Schematic / Schema

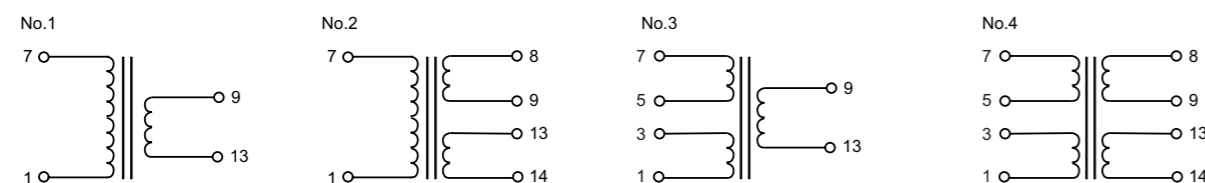

Schematic / Schema

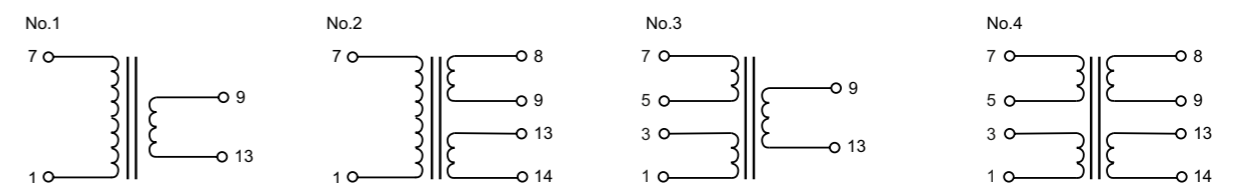

TRANSFORMER EI 54/18.8 16.00 VA

- Frequency / Frequenz 50/60 Hz
- Potted under vacuum / Vakuumvergossen
- Split-bobbin / Zweikammer-Wicklung
- Temperature class / Temperaturklasse ta 70 °C/F
- Short-circuit-proof / Kurzschlussfest
- Weight / Gewicht 0.295 kg
- Other primary and secondary voltages on request / Weitere Primär- und Sekundärspannungen auf Anfrage
- DIN EN 60335-1 glow wire test / Glühdrahtprüfung

TRANSFORMER EI 54/18.8 16.00 VA

- Frequency / Frequenz 50/60 Hz
- Potted under vacuum / Vakuumvergossen
- Split-bobbin / Zweikammer-Wicklung
- Temperature class / Temperaturklasse ta 70 °C/F
- Short-circuit-proof / Kurzschlussfest
- Weight / Gewicht 0.42 kg
- Other primary and secondary voltages on request / Weitere Primär- und Sekundärspannungen auf Anfrage
- DIN EN 60335-1 glow wire test / Glühdrahtprüfung



Primary (V) Primär (V)	Secondary (V) Sekundär (V)	mA	No-Load Voltage (V) Leerlaufspannung (V)	Schematic-No. Schema-Nr.	Part.-No. Sachnummer	Approvals Approbationen
2 x 115	6	2666.67		3	07-1027-14	1/4
2 x 115	7.5	2133.33		3	07-1028-14	1/4
2 x 115	9	1777.78		3	07-1029-14	1/4
2 x 115	12	1333.33		3	07-1030-14	1/4
2 x 115	15	1066.67		3	07-1031-14	1/4
2 x 115	18	888.89		3	07-1032-14	1/4
2 x 115	21	761.90		3	07-1033-14	1/4
2 x 115	24	666.67		3	07-1034-14	1/4
2 x 115	2 x 6	1333.33		4	07-1035-14	1/4
2 x 115	2 x 7.5	1066.67		4	07-1036-14	1/4
2 x 115	2 x 9	888.89		4	07-1037-14	1/4
2 x 115	2 x 12	666.67		4	07-1038-14	1/4
2 x 115	2 x 15	533.33		4	07-1039-14	1/4

Primary (V) Primär (V)	Secondary (V) Sekundär (V)	mA	No-Load Voltage (V) Leerlaufspannung (V)	Schematic-No. Schema-Nr.	Part.-No. Sachnummer	Approvals Approbationen
230	6	2666.67		1	07-1101-14	1/4
230	7.5	2133.33		1	07-1102-14	1/4
230	9	1777.78		1	07-1103-14	1/4
230	12	1333.33		1	07-1104-14	1/4
230	15	1066.67		1	07-1105-14	1/4
230	18	888.89		1	07-1106-14	1/4
230	21	761.90		1	07-1107-14	1/4
230	24	666.67		1	07-1108-14	1/4
230	2 x 6	1333.33		2	07-1109-14	1/4
230	2 x 7.5	1066.67		2	07-1110-14	1/4
230	2 x 9	888.89		2	07-1112-14	1/4
230	2 x 12	666.67		2	07-1113-14	1/4
230	2 x 15	533.33		2	07-1114-14	1/4

Subject to technical changes / Technische Änderungen vorbehalten!

Subject to technical changes / Technische Änderungen vorbehalten!

Mechanical dimensions / Mechanische Abmessungen

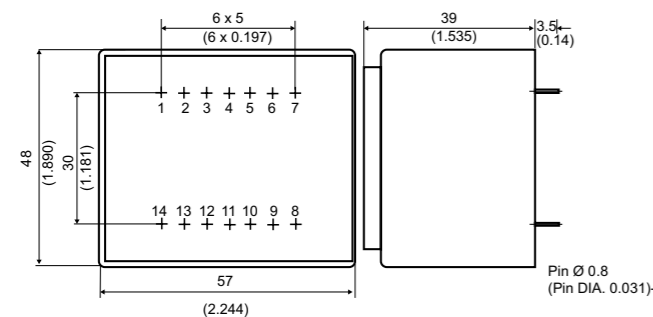

Approvals / Approbationen

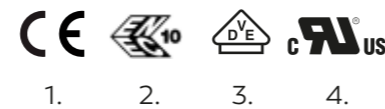

Schematic / Schema

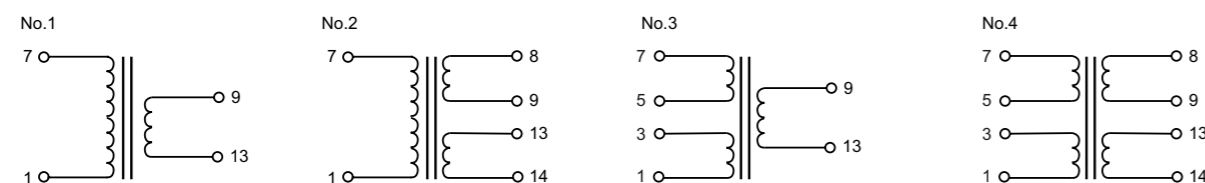

Mechanical dimensions / Mechanische Abmessungen

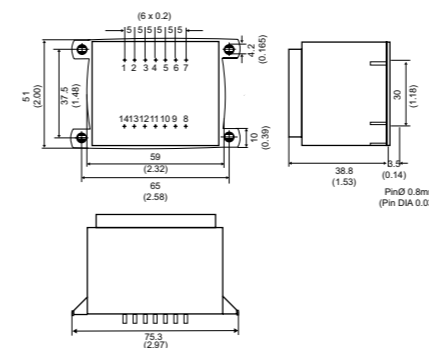

Approvals / Approbationen

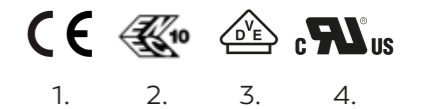

Schematic / Schema

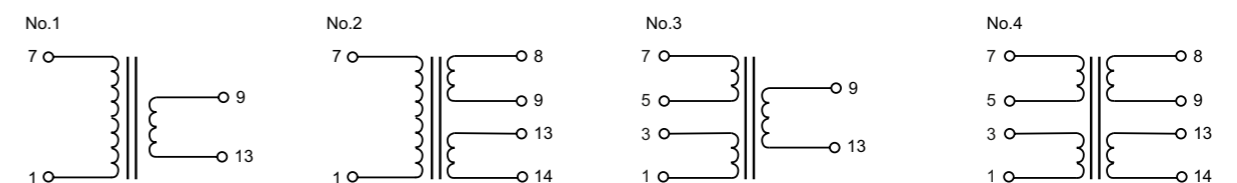

TRANSFORMER EI 60/21 20.00 VA

- Frequency / Frequenz 50/60 Hz
- Potted under vacuum / Vakuumvergossen
- Split-bobbin / Zweikammer-Wicklung
- Temperature class / Temperaturklasse ta 70 °C/F
- Short-circuit-proof / Kurzschlussfest
- Weight / Gewicht 0.295 kg
- Other primary and secondary voltages on request / Weitere Primär- und Sekundärspannungen auf Anfrage
- DIN EN 60335-1 glow wire test / Glühdrahtprüfung



TRANSFORMER EI 60/21 20.00 VA

- Frequency / Frequenz 50/60 Hz
- Potted under vacuum / Vakuumvergossen
- Split-bobbin / Zweikammer-Wicklung
- Temperature class / Temperaturklasse ta 70 °C/F
- Short-circuit-proof / Kurzschlussfest
- Weight / Gewicht 0.295 kg
- Other primary and secondary voltages on request / Weitere Primär- und Sekundärspannungen auf Anfrage
- DIN EN 60335-1 glow wire test / Glühdrahtprüfung



Primary (V) Primär (V)	Secondary (V) Sekundär (V)	mA	No-Load Voltage (V) Leerlaufspannung (V)	Schematic-No. Schema-Nr.	Part.-No. Sachnummer	Approvals Approbationen
115	6	3333.33		1	08-1014-14	1/4
115	7.5	2666.67		1	08-1015-14	1/4
115	9	2222.22		1	08-1016-14	1/4
115	12	1666.67		1	08-1017-14	1/4
115	15	1333.33		1	08-1018-14	1/4
115	18	1111.11		1	08-1019-14	1/4
115	21	952.38		1	08-1020-14	1/4
115	24	833.33		1	08-1021-14	1/4
115	2 x 6	1666.67		2	08-1022-14	1/4
115	2 x 7.5	1333.33		2	08-1023-14	1/4
115	2 x 9	1111.11		2	08-1024-14	1/4
115	2 x 12	833.33		2	08-1025-14	1/4
115	2 x 15	666.66		2	08-1026-14	1/4

Subject to technical changes / Technische Änderungen vorbehalten!

Primary (V) Primär (V)	Secondary (V) Sekundär (V)	mA	No-Load Voltage (V) Leerlaufspannung (V)	Schematic-No. Schema-Nr.	Part.-No. Sachnummer	Approvals Approbationen
230	6	3333.33		1	08-1001-14	1/4
230	7.5	2666.67		1	08-1002-14	1/4
230	9	2222.22		1	08-1003-14	1/4
230	12	1666.67		1	08-1004-14	1/4
230	15	1333.33		1	08-1005-14	1/4
230	18	1111.11		1	08-1006-14	1/4
230	21	952.38		1	08-1007-14	1/4
230	24	833.33		1	08-1008-14	1/4
230	2 x 6	1666.67		2	08-1009-14	1/4
230	2 x 7.5	1333.33		2	08-1010-14	1/4
230	2 x 9	1111.11		2	08-1011-14	1/4
230	2 x 12	833.33		2	08-1012-14	1/4
230	2 x 15	666.66		2	08-1013-14	1/4

Subject to technical changes / Technische Änderungen vorbehalten!

Mechanical dimensions / Mechanische Abmessungen

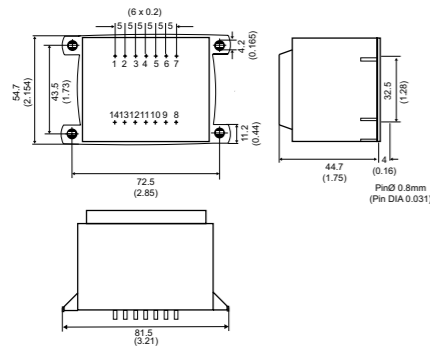

Approvals / Approbationen

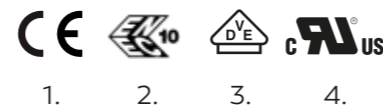

Schematic / Schema

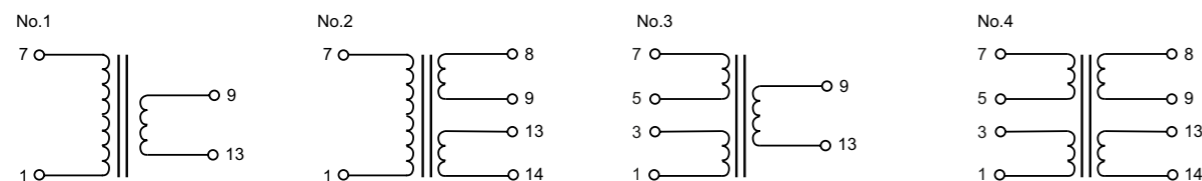

Mechanical dimensions / Mechanische Abmessungen

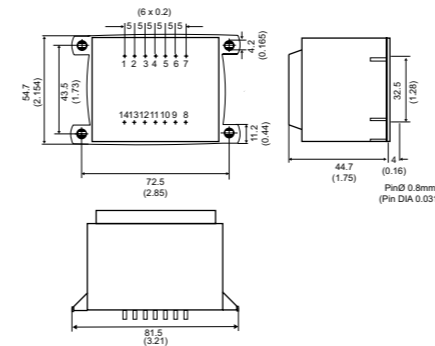

Approvals / Approbationen

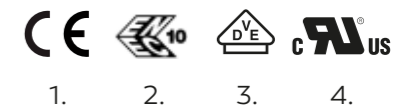

Schematic / Schema



TRANSFORMER EI 60/21 20.00 VA

- Frequency / Frequenz 50/60 Hz
- Potted under vacuum / Vakuumvergossen
- Split-bobbin / Zweikammer-Wicklung
- Temperature class / Temperaturklasse ta 70 °C/F
- Short-circuit-proof / Kurzschlussfest
- Weight / Gewicht 0.295 kg
- Other primary and secondary voltages on request / Weitere Primär- und Sekundärspannungen auf Anfrage
- DIN EN 60335-1 glow wire test / Glühdrahtprüfung



TRANSFORMER EI 60/25.5 28.00 VA

- Frequency / Frequenz 50/60 Hz
- Potted under vacuum / Vakuumvergossen
- Split-bobbin / Zweikammer-Wicklung
- Temperature class / Temperaturklasse ta 70 °C/F
- Short-circuit-proof / Kurzschlussfest
- Weight / Gewicht 0.67 kg
- Other primary and secondary voltages on request / Weitere Primär- und Sekundärspannungen auf Anfrage
- DIN EN 60335-1 glow wire test / Glühdrahtprüfung



Primary (V) Primär (V)	Secondary (V) Sekundär (V)	mA	No-Load Voltage (V) Leerlaufspannung (V)	Schematic-No. Schema-Nr.	Part.-No. Sachnummer	Approvals Approbationen
2 x 115	6	3333.33		3	08-1027-14	1/4
2 x 115	7.5	2666.67		3	08-1028-14	1/4
2 x 115	9	2222.22		3	08-1029-14	1/4
2 x 115	12	1666.67		3	08-1030-14	1/4
2 x 115	15	1333.33		3	08-1031-14	1/4
2 x 115	18	1111.11		3	08-1032-14	1/4
2 x 115	21	952.38		3	08-1033-14	1/4
2 x 115	24	833.33		3	08-1034-14	1/4
2 x 115	2 x 6	1666.67		4	08-1035-14	1/4
2 x 115	2 x 7.5	1333.33		4	08-1036-14	1/4
2 x 115	2 x 9	1111.11		4	08-1037-14	1/4
2 x 115	2 x 12	833.33		4	08-1038-14	1/4
2 x 115	2 x 15	666.66		4	08-1039-14	1/4

Subject to technical changes / Technische Änderungen vorbehalten!

Primary (V) Primär (V)	Secondary (V) Sekundär (V)	mA	No-Load Voltage (V) Leerlaufspannung (V)	Schematic-No. Schema-Nr.	Part.-No. Sachnummer	Approvals Approbationen
115	6	4666.67		1	08-2014-14	1/4
115	7.5	3733.33		1	08-2015-14	1/4
115	9	3111.2112		1	08-2016-14	1/4
115	12	2333.33		1	08-2017-14	1/4
115	15	1866.67		1	08-2018-14	1/4
115	18	1555.56		1	08-2019-14	1/4
115	21	1333.33		1	08-2020-14	1/4
115	24	1166.67		1	08-2021-14	1/4
115	2 x 6	2333.33		2	08-2022-14	1/4
115	2 x 7.5	1866.67		2	08-2023-14	1/4
115	2 x 9	1555.56		2	08-2024-14	1/4
115	2 x 12	1166.67		2	08-2025-14	1/4
115	2 x 15	933.33		2	08-2026-14	1/4

Subject to technical changes / Technische Änderungen vorbehalten!

Mechanical dimensions / Mechanische Abmessungen

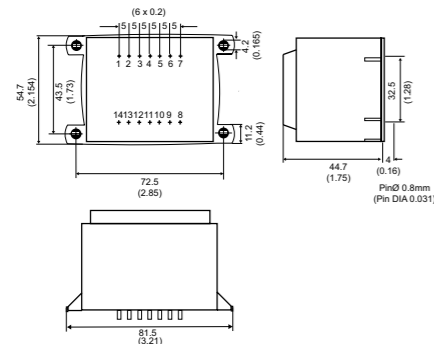

Approvals / Approbationen

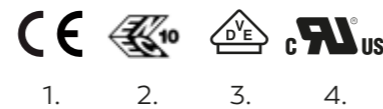

Schematic / Schema

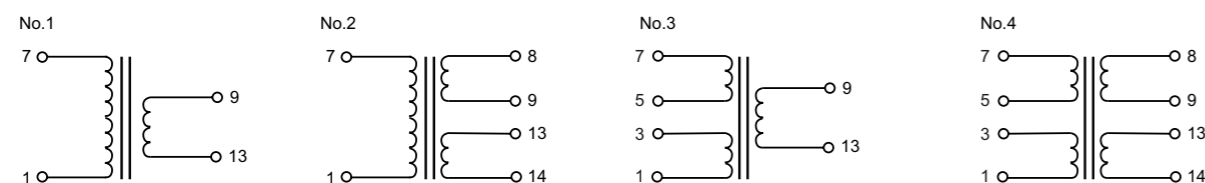

Mechanical dimensions / Mechanische Abmessungen

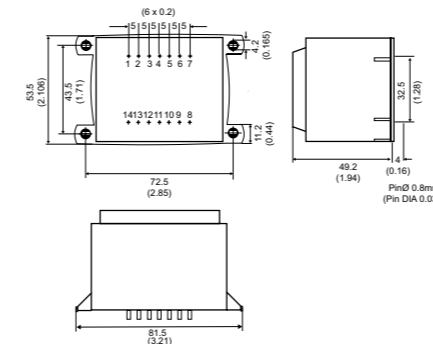

Approvals / Approbationen

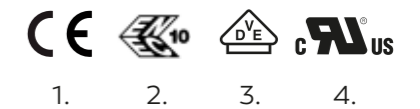

Schematic / Schema

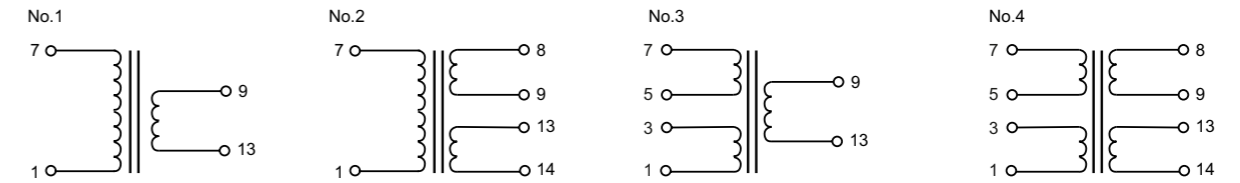

TRANSFORMER EI 66/23 33.00 VA

- Frequency / Frequenz 50/60 Hz
- Potted under vacuum / Vakuumvergossen
- Split-bobbin / Zweikammer-Wicklung
- Temperature class / Temperaturklasse ta 70 °C/F
- Short-circuit-proof / Kurzschlussfest
- Weight / Gewicht 0.75 kg
- Other primary and secondary voltages on request / Weitere Primär- und Sekundärspannungen auf Anfrage
- DIN EN 60335-1 glow wire test / Glühdrahtprüfung



TRANSFORMER EI 66/23 33.00 VA

- Frequency / Frequenz 50/60 Hz
- Potted under vacuum / Vakuumvergossen
- Split-bobbin / Zweikammer-Wicklung
- Temperature class / Temperaturklasse ta 70 °C/F
- Short-circuit-proof / Kurzschlussfest
- Weight / Gewicht 0.75 kg
- Other primary and secondary voltages on request / Weitere Primär- und Sekundärspannungen auf Anfrage
- DIN EN 60335-1 glow wire test / Glühdrahtprüfung



Primary (V) Primär (V)	Secondary (V) Sekundär (V)	mA	No-Load Voltage (V) Leerlaufspannung (V)	Schematic-No. Schema-Nr.	Part.-No. Sachnummer	Approvals Approbationen
115	6	5500.00		1	09-2014-14	1/4
115	7.5	4400.00		1	09-2015-14	1/4
115	9	3666.67		1	09-2016-14	1/4
115	12	2750.00		1	09-2017-14	1/4
115	15	2200.00		1	09-2018-14	1/4
115	18	1833.33		1	09-2019-14	1/4
115	21	1571.43		1	09-2020-14	1/4
115	24	1375.00		1	09-2021-14	1/4
115	2 x 6	2750.00		2	09-2022-14	1/4
115	2 x 7.5	2200.00		2	09-2023-14	1/4
115	2 x 9	1833.33		2	09-2024-14	1/4
115	2 x 12	1375.00		2	09-2025-14	1/4
115	2 x 15	1100.00		2	09-2026-14	1/4

Primary (V) Primär (V)	Secondary (V) Sekundär (V)	mA	No-Load Voltage (V) Leerlaufspannung (V)	Schematic-No. Schema-Nr.	Part.-No. Sachnummer	Approvals Approbationen
230	6	5500.00		1	09-2001-04	1/4
230	7.5	4400.00		1	09-2002-04	1/4
230	9	3666.67		1	09-2003-04	1/4
230	12	2750.00		1	09-2004-04	1/4
230	15	2200.00		1	09-2005-04	1/4
230	18	1833.33		1	09-2006-04	1/4
230	21	1571.43		1	09-2007-04	1/4
230	24	1375.00		1	09-2008-04	1/4
230	2 x 6	2750.00		2	09-2009-04	1/4
230	2 x 7.5	2200.00		2	09-2010-04	1/4
230	2 x 9	1833.33		2	09-2011-04	1/4
230	2 x 12	1375.00		2	09-2012-04	1/4
230	2 x 15	1100.00		2	09-2013-04	1/4

Subject to technical changes / Technische Änderungen vorbehalten!

Subject to technical changes / Technische Änderungen vorbehalten!

Mechanical dimensions / Mechanische Abmessungen

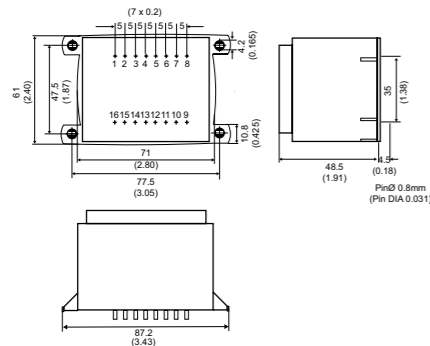

Approvals / Approbationen



Schematic / Schema

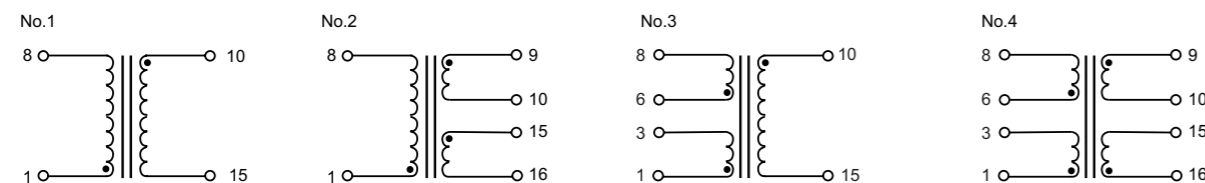

Mechanical dimensions / Mechanische Abmessungen

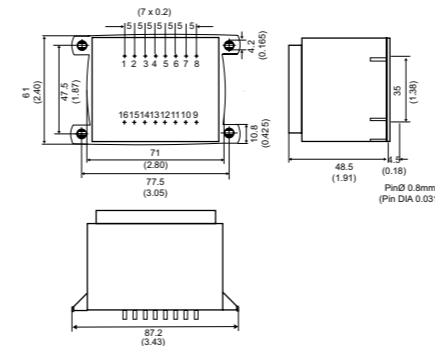

Approvals / Approbationen



Schematic / Schema

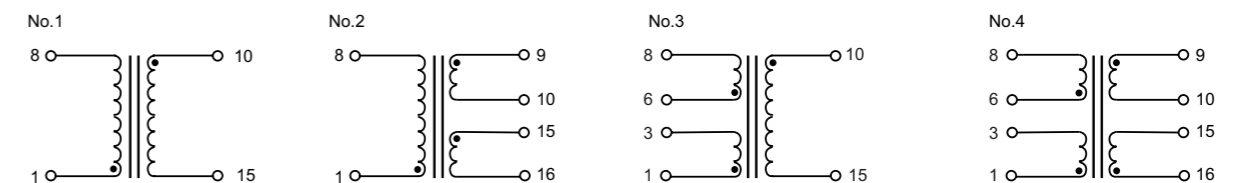

TRANSFORMER EI 66/23 33.00 VA

- Frequency / Frequenz 50/60 Hz
- Potted under vacuum / Vakuumvergossen
- Split-bobbin / Zweikammer-Wicklung
- Temperature class / Temperaturklasse ta 70 °C/F
- Short-circuit-proof / Kurzschlussfest
- Weight / Gewicht 0.75 kg
- Other primary and secondary voltages on request / Weitere Primär- und Sekundärspannungen auf Anfrage
- DIN EN 60335-1 glow wire test / Glühdrahtprüfung



TRANSFORMER EI 66/34.8 47.00 VA

- Frequency / Frequenz 50/60 Hz
- Potted under vacuum / Vakuumvergossen
- Split-bobbin / Zweikammer-Wicklung
- Temperature class / Temperaturklasse ta 70 °C/F
- Short-circuit-proof / Kurzschlussfest
- Weight / Gewicht 1.04 kg
- Other primary and secondary voltages on request / Weitere Primär- und Sekundärspannungen auf Anfrage
- DIN EN 60335-1 glow wire test / Glühdrahtprüfung



Primary (V) Primär (V)	Secondary (V) Sekundär (V)	mA	No-Load Voltage (V) Leerlaufspannung (V)	Schematic-No. Schema-Nr.	Part.-No. Sachnummer	Approvals Approbationen
2 x 115	6	5500.00		3	09-2027-14	1/4
2 x 115	7.5	4400.00		3	09-2028-14	1/4
2 x 115	9	3666.67		3	09-2029-14	1/4
2 x 115	12	2750.00		3	09-2030-14	1/4
2 x 115	15	2200.00		3	09-2031-14	1/4
2 x 115	18	1833.33		3	09-2032-14	1/4
2 x 115	21	1571.43		3	09-2033-14	1/4
2 x 115	24	1375.00		3	09-2034-14	1/4
2 x 115	2 x 6	2750.00		4	09-2035-14	1/4
2 x 115	2 x 7.5	2200.00		4	09-2036-14	1/4
2 x 115	2 x 9	1833.33		4	09-2037-14	1/4
2 x 115	2 x 12	1375.00		4	09-2038-14	1/4
2 x 115	2 x 15	1100.00		4	09-2039-14	1/4

Subject to technical changes / Technische Änderungen vorbehalten!

Primary (V) Primär (V)	Secondary (V) Sekundär (V)	mA	No-Load Voltage (V) Leerlaufspannung (V)	Schematic-No. Schema-Nr.	Part.-No. Sachnummer	Approvals Approbationen
115	6	7833.33		1	09-4014-04	1/4
115	7.5	6266.67		1	09-4015-04	1/4
115	9	5222.22		1	09-4016-04	1/4
115	12	3916.67		1	09-4017-04	1/4
115	15	3133.33		1	09-4018-04	1/4
115	18	2611.11		1	09-4019-04	1/4
115	21	2238.10		1	09-4020-04	1/4
115	24	1958.33		1	09-4021-04	1/4
115	2 x 6	3916.67		2	09-4022-04	1/4
115	2 x 7.5	3133.33		2	09-4023-04	1/4
115	2 x 12	2611.11		2	09-4024-04	1/4
115	2 x 15	1958.33		2	09-4025-04	1/4
115	2 x 18	1566.66		2	09-4026-04	1/4

Subject to technical changes / Technische Änderungen vorbehalten!

Mechanical dimensions / Mechanische Abmessungen

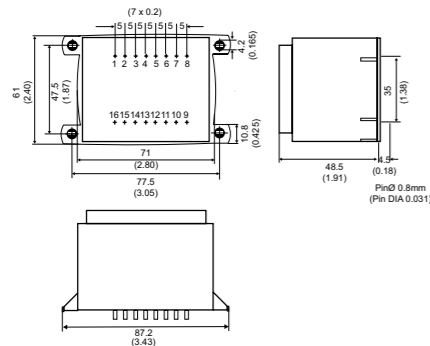

Approvals / Approbationen



Schematic / Schema

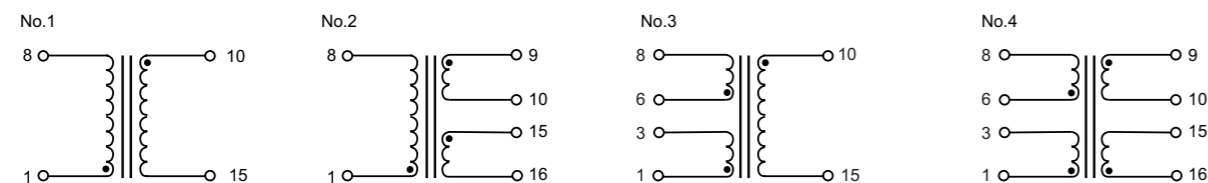

Mechanical dimensions / Mechanische Abmessungen

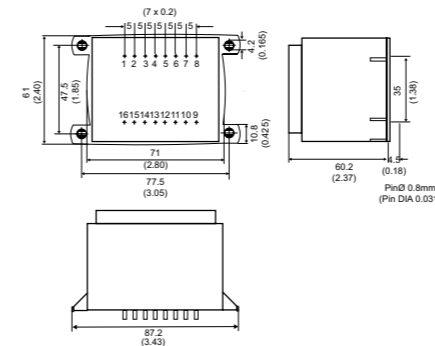

Approvals / Approbationen



Schematic / Schema

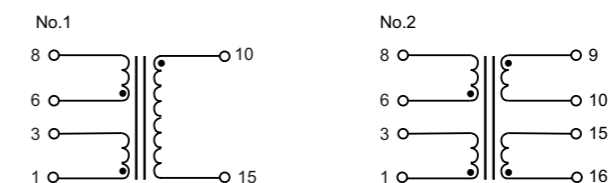

TRANSFORMER EI 66/34.8 47.00 VA

- Frequency / Frequenz 50/60 Hz
- Potted under vacuum / Vakuumvergossen
- Split-bobbin / Zweikammer-Wicklung
- Temperature class / Temperaturklasse ta 70 °C/F
- Short-circuit-proof / Kurzschlussfest
- Weight / Gewicht 1.04 kg
- Other primary and secondary voltages on request / Weitere Primär- und Sekundärspannungen auf Anfrage
- DIN EN 60335-1 glow wire test / Glühdrahtprüfung



TRANSFORMER EI 66/34.8 47.00 VA

- Frequency / Frequenz 50/60 Hz
- Potted under vacuum / Vakuumvergossen
- Split-bobbin / Zweikammer-Wicklung
- Temperature class / Temperaturklasse ta 70 °C/F
- Short-circuit-proof / Kurzschlussfest
- Weight / Gewicht 1.04 kg
- Other primary and secondary voltages on request / Weitere Primär- und Sekundärspannungen auf Anfrage
- DIN EN 60335-1 glow wire test / Glühdrahtprüfung



Primary (V) Primär (V)	Secondary (V) Sekundär (V)	mA	No-Load Voltage (V) Leerlaufspannung (V)	Schematic-No. Schema-Nr.	Part.-No. Sachnummer	Approvals Approbationen
230	6	7833.33		1	09-4001-04	1/4
230	7.5	6266.67		1	09-4002-04	1/4
230	9	5222.22		1	09-4003-04	1/4
230	12	3916.67		1	09-4004-04	1/4
230	15	3133.33		1	09-4005-04	1/4
230	18	2611.11		1	09-4006-04	1/4
230	21	2238.10		1	09-4007-04	1/4
230	24	1958.33		1	09-4008-04	1/4
230	2 x 6	3916.67		2	09-4009-04	1/4
230	2 x 7.5	3133.33		2	09-4010-04	1/4
230	2 x 9	2611.11		2	09-4011-04	1/4
230	2 x 12	1958.33		2	09-4012-04	1/4
230	2 x 15	1566.66		2	09-4013-04	1/4

Primary (V) Primär (V)	Secondary (V) Sekundär (V)	mA	No-Load Voltage (V) Leerlaufspannung (V)	Schematic-No. Schema-Nr.	Part.-No. Sachnummer	Approvals Approbationen
2 x 115	6	7833.33		1	09-4027-04	1/4
2 x 115	7.5	6266.67		1	09-4028-04	1/4
2 x 115	9	5222.22		1	09-4029-04	1/4
2 x 115	12	3916.67		1	09-4030-04	1/4
2 x 115	15	3133.33		1	09-4031-04	1/4
2 x 115	18	2611.11		1	09-4032-04	1/4
2 x 115	21	2238.10		1	09-4033-04	1/4
2 x 115	24	1958.33		1	09-4034-04	1/4
2 x 115	2 x 6	3916.67		2	09-4035-04	1/4
2 x 115	2 x 7.5	3133.33		2	09-4036-04	1/4
2 x 115	2 x 9	2611.11		2	09-4037-04	1/4
2 x 115	2 x 12	1958.33		2	09-4038-04	1/4
2 x 115	2 x 15	1566.66		2	09-4039-04	1/4

Subject to technical changes / Technische Änderungen vorbehalten!

Subject to technical changes / Technische Änderungen vorbehalten!

Mechanical dimensions / Mechanische Abmessungen

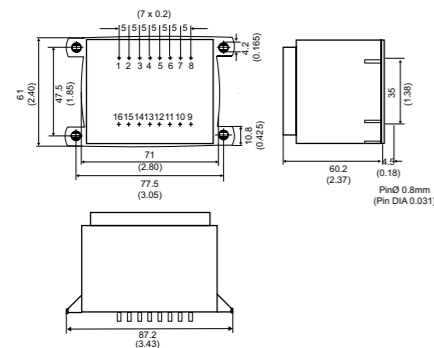

Approvals / Approbationen



1. 2.

Schematic / Schema

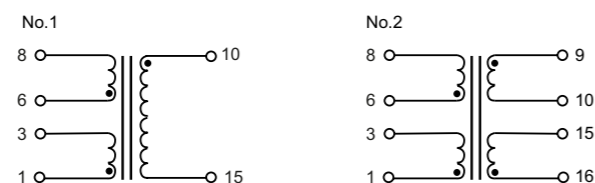

Mechanical dimensions / Mechanische Abmessungen

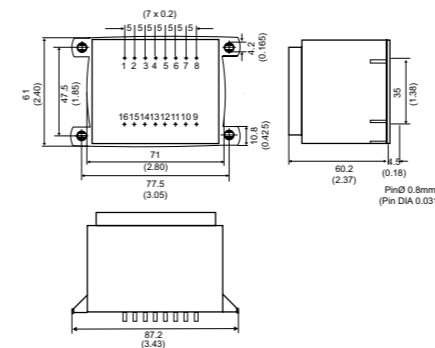

Approvals / Approbationen



1. 2.

Schematic / Schema

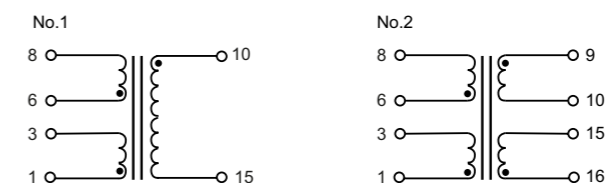

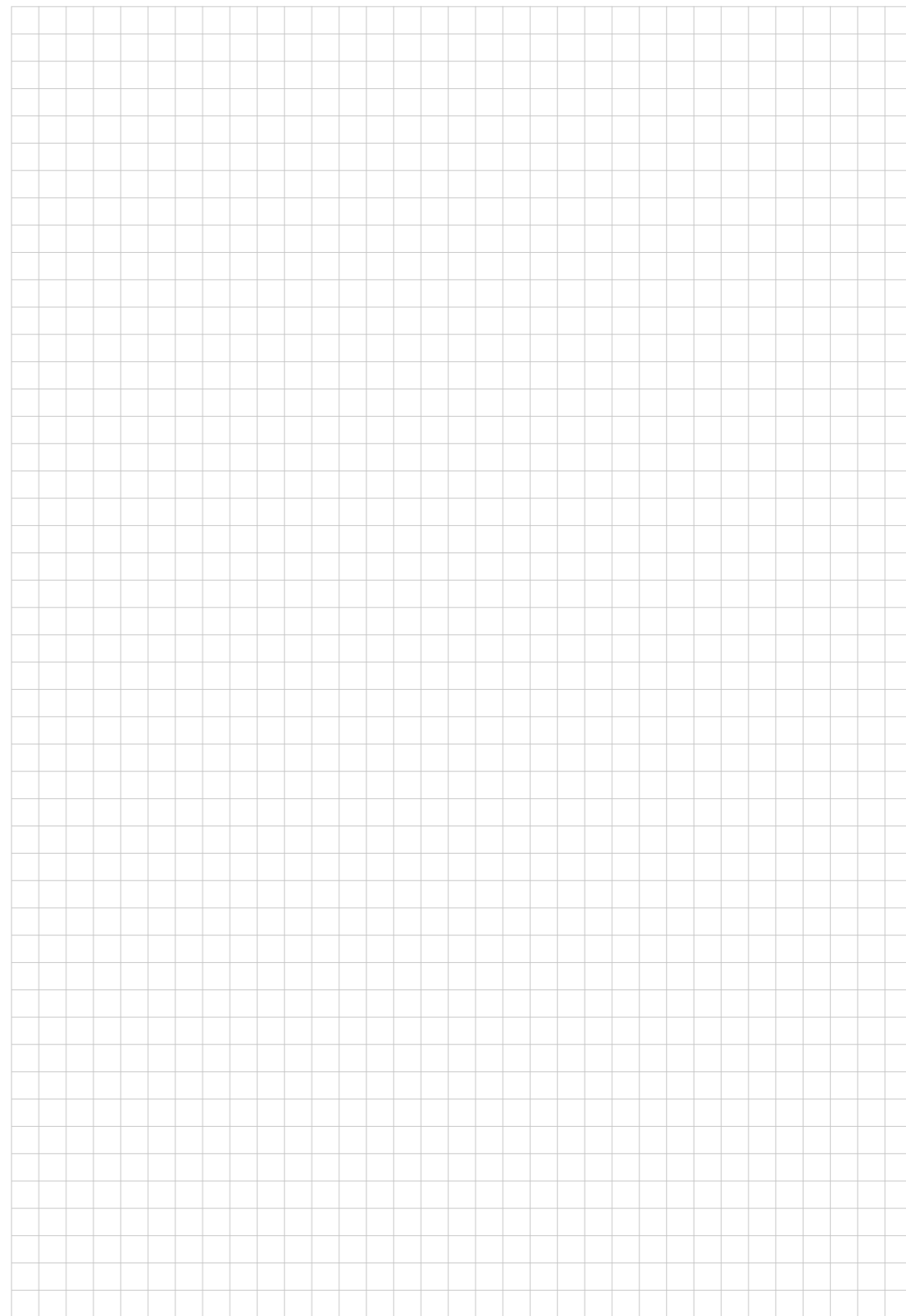
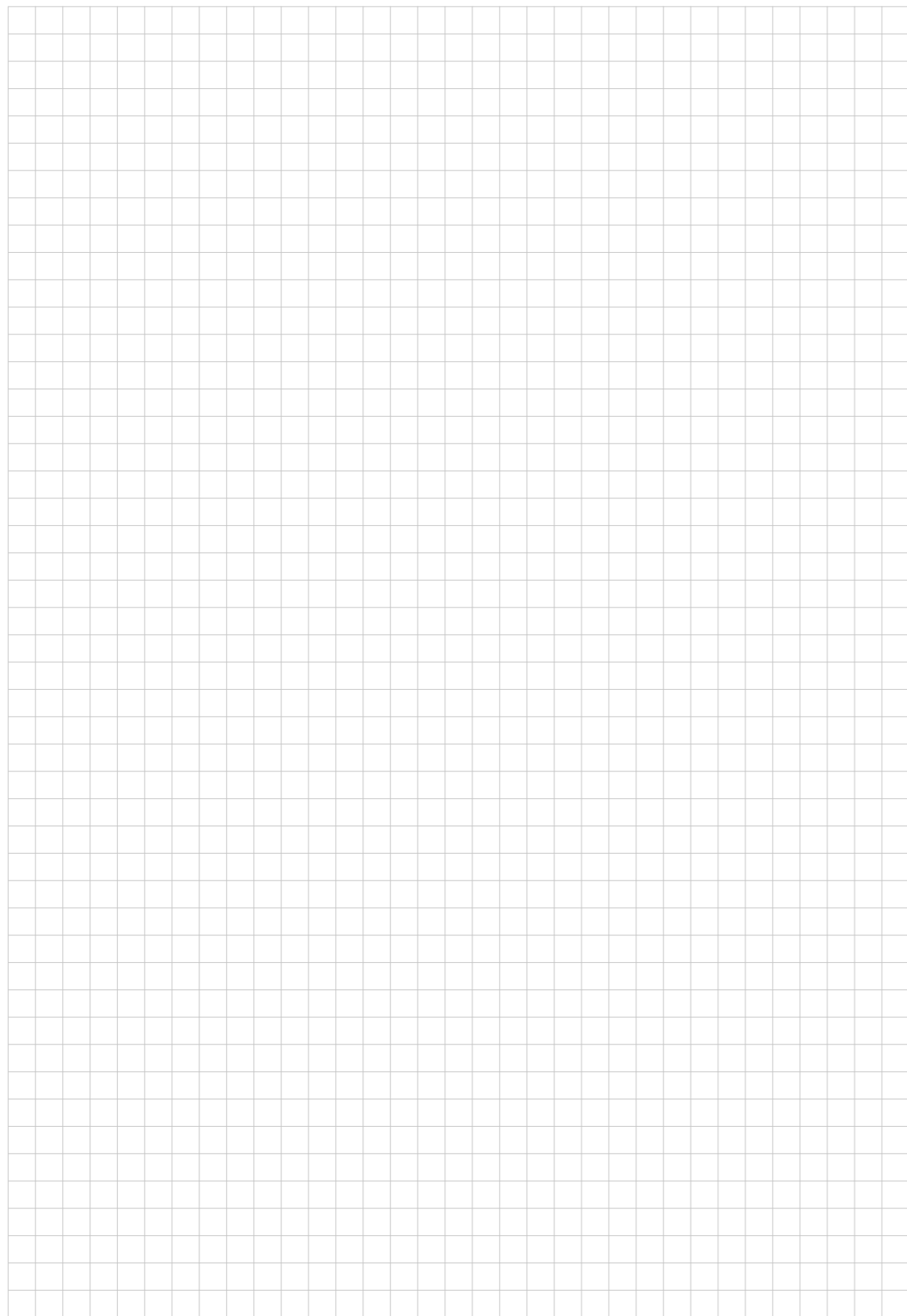



LOCATIONS

● // **SCHWA-MEDICO GmbH** // Philipp-Reis-Straße 5 // 35321 Laubach, Germany
Phone: +49 6405 50580-0 // Fax: +49 6405 3763 // info@smtrafo.com

● // **SCHNEEFUSS + ROHDE GmbH** // Raiffeisenstraße 5 // 21379 Scharnebeck, Germany
Phone: +49 4136 91302-0 // Fax: +49 4136 91302-22 // info@schneefuss.de

● // **MANFRED SCHMELZER GmbH** // Waidplatzstraße 6–8 // 79331 Teningen-Nimburg, Germany
Phone: +49 7663 9447-0 // Fax: +49 7663 9447-50 // info@ms-transformers.de

● // **MS BALTI Trafo OÜ** // Vihtra tee 3a // 87701 Vändra, Estonia
Phone: +372 447 166-0 // Fax: +372 447 166-7 // info@msbaltitrafo.ee

● // **TECH POWER ELECTRONICS** // ZI Les Plaines // 39570 Courlaoux, France
Phone: +33 384 252626 // Fax: +33 384 252610 // sales@techpowerelectronics.com

● // **MCT TRANSFORMATOREN GmbH** // Oberurseler Straße 61–63 // 61440 Oberursel, Germany
Phone: +49 6171 501-0 // Fax: +49 6171 501-311 // mct@tpe.group

○ // **SCHWA-MEDICO GmbH** // Schwa-Medico Electrical Co., Ltd
2F, Building A4, No. 128 Hongye Road // 215021 Industria Park // Suzhou, China

○ // **SCHWA-MEDICO KFT.** // Ajka, Téglagyári u. 21 // 8400 Hungary
Phone: +36 88 500 410

○ // **MS INDIA** // M.S Transformers India Pvt Ltd. // 1/512, Avinashi Main Road, Neelambur PostSulur Tk,
Coimbatore - 641 062, Tamil Nadu, India // Phone: +91 97509-28810

○ // **MS SIMO** // SIMO Tunisie S.A.R.L. Zone Industrielle El Alia 7016 E Alia Bizerte, Tunisia

○ // **ROMANELEC** // Str. Aurel Vlaicu 37–39 // 551041 Medias, Romania // Phone: +40 269 831877 // Fax: +40 269 831738

○ // **TRANSFORMATORUL** // Str. Faurilor Nr 140–142 // 310489 Arad, Romania // Phone: +40 257 272233

○ // **TEAM MAGNETICS INTERNATIONAL GmbH** // Daimlerstraße 12 // 71083 Herrenberg, Germany
Phone: +49 7032 95607-0 // Fax: +49 7032 95607-11 // teammagnetics@tpe.group

● Development & manufacture
○ Production



TECH POWER
ELECTRONICS GROUP

www.tpe.group